

200CENT SERIES

RECESSED TRIMLESS

Tiny, powerful, exceptional color? It's possible with the 200Cent Series. At just 1.02" (26mm), the aperture is the same size as a 2 Euro coin, hence its name. Available in a vast array of options (fixed, adjustable, trimless, trimmed, pendant) the 200Cent series has a fixture for every application.



Ceiling Cut-Out: 4.49" x 5.28"
Fixture Dimensions

TECHNICAL DATA

Wattage / Input	3W (1050mA), 5.9W (700mA), 6.2W (250mA)
Power Supply	Remote, not included. See page 2.
Construction	Fixture: Aluminum Body: CALCYT®
CCT	2200K, 2400K (only available on the 6.2W version), 2700K, 3000K, 4000K
CRI	>92
Delivered Lumens	212 lm (3W, 3000K, 12°); 438 lm (5.9W, 3000K, 24°); 562 lm (6.2W, 3000K, 36°)
Luminaire Efficacy	71 lm/W (3W); 74 lm/W (5.9W); 91 lm/W (6.2W)
Optics	12° (3W version); 24° (5.9W version) 36° (6.2W version)
Finishes	5 Standard. See below and page 2.
Cut-Out Dimensions	4.49" x 5.28"
Fixture Dimensions	Ø1.04" x 3.11" h
Calcyt® Dimensions	4.33" x 5.12"
Aperture	Ø1.02"
LED Source	1 A+ LED
Color Consistency	2-Step MacAdam
IP Rating	IP20

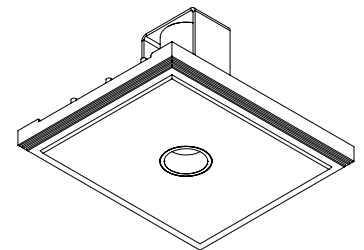
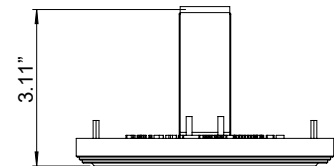
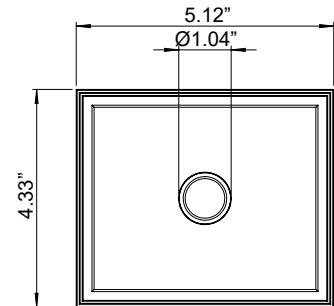

ORDERING INFORMATION

Example: 250 29 530 200 GOLD. Accessories / Power Supplies ordered separately.

Model No.	CCT	Finish
250 27 (3W - 250LM)	530 - 2200K, 2400K	200 BLACK - Black
250 28 (5.9W - 500LM)	(2400K for the 6.2W version)	200 WHITE - White
250 29 (6.2W - 750LM)	930 - 2700K	200 CHROME - Chrome
	830 - 3000K	200 GOLD - Gold
	730 - 4000K	200 COPPER - Copper

Job Name/Date:

Fixture Type Designation:

200CENT SERIES

RECESSED TRIMLESS

SUGGESTED POWER SUPPLIES

1050mA - 3W version (250LM)

Part Number	Description	Input/Output	# of Fixtures
PPLT00466-P	0-10V Dimming to 1.0%	120-277VAC to 1050mA, 10W Class 2	1-2
PPLT00465-P	0-10V Dimming to 1.0%	120-277VAC to 1050mA, 20W Class 2	1-6
PPLT00480-P	0-10V Dimming to 1.0%	120-277VAC to 1050mA, 30W Class 2	1-10
PPLT00309-P	0-10V Dimming to 1.0%	120-277VAC to 1050mA, 50W Class 2	1-16
PPLT00538-P	0-10V Dimming to 0.1% (4 channels)	120-277VAC to 1050mA, 100W Class 2	1-8 (1-32)

700mA - 5.9W version (500LM)

Part Number	Description	Input/Output	# of Fixtures
PPLT00466-P	0-10V Dimming to 1.0%	120-277VAC to 700mA, 10W Class 2	1-1
PPLT00470	Phase Dim (120V Only)	120-277VAC to 700mA, 14W Class 2	1-2
PPLT00465-P	0-10V Dimming to 1.0%	120-277VAC to 700mA, 20W Class 2	1-3
PPLT00261	Leading / Trailing-Edge Dimming to 10% (120V only)	120-277VAC to 700mA, 32W Class 2	3-5
PPLT00467-P	0-10V Dimming to 1.0%	120-277VAC to 700mA, 50W Class 2	1-6
PPLT00538-P	0-10V Dimming to 0.1% (4 channels)	120-277VAC to 700mA, 100W Class 2	1-4 (1-16)

Suggested Lutron Compatible - 700mA - 5.9W version (500LM)

Part Number	Option	Lutron SKU	Dim Range	Description	Input/Output	# of Fixtures
PPLT00515	L3DAE / L3DA3W	L3DA	100%-1%	Hi-Lume™ 1% EcoSystem™ or 1% 3-Wire LED Driv.	120-277VAC to 700mA, 14W, Class 2	1-2
PPLT00517	L3DAE / L3DA3W	L3DA	100%-1%	Hi-Lume™ 1% EcoSystem™ or 1% 3-Wire LED Driv.	120-277VAC to 700mA, 27W, Class 2	2-4
PPLT00181	L3DAE / L3DA3W	L3DA	100%-1%	Hi-Lume™ 1% EcoSystem™ or 1% 3-Wire LED Driv.	120-277VAC to 700mA, 38W, Class 2	4-5

250mA - 6.2W version (750LM)

Part Number	Description	Input/Output	# of Fixtures
PPLT00466-P	0-10V Dimming to 1.0%	120-277VAC to 250mA, 10W Class 2	1-1
PPLT00290	Leading / Trailing Edge Dimming to 10% (120V Only)	120-277VAC to 250mA, 16W Class 2	1-1
PPLT00465-P	0-10V Dimming to 1.0%	120-277VAC to 250mA, 20W Class 2	1-2
PPLT00467-P	0-10V Dimming to 1.0%	120-277VAC to 250mA, 50W Class 2	1-2
PPLT00538-P	0-10V Dimming to 0.1% (4 channels)	120-277VAC to 250mA, 100W Class 2	1-4 (1-8)

For other power supply options consult factory.

Job Name/Date:

Fixture Type Designation:

200CENT SERIES

RECESSED TRIMLESS

ACCESSORIES - Installation

STANDARD (included)
installation system for ceiling 0.35" - 0.47" - 0.59"

Consult factory for optional housing ordering information.

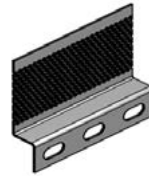

200 99 025
(Set of 2) for ceiling 0.98"

200 99 030
(Set of 2) for ceiling 1.18"

FINISHES



PHOTOMETRIC DATA

Note: All photometry is 3000K

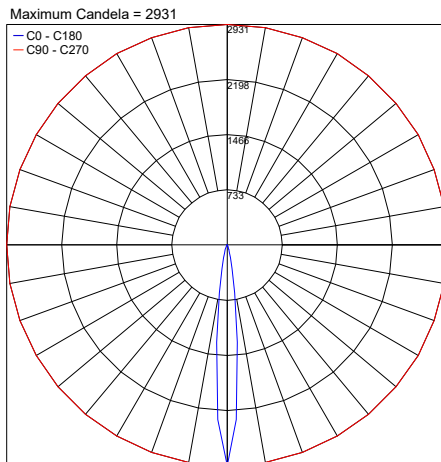

PHOTOMETRIC FILENAME : 200CENT FIX TRIMLESS 3W 12".IES

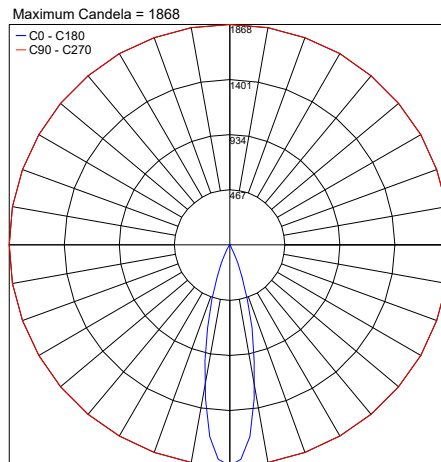

PHOTOMETRIC FILENAME : 200CENT FIX TRIMLESS 5.9W 24".IES

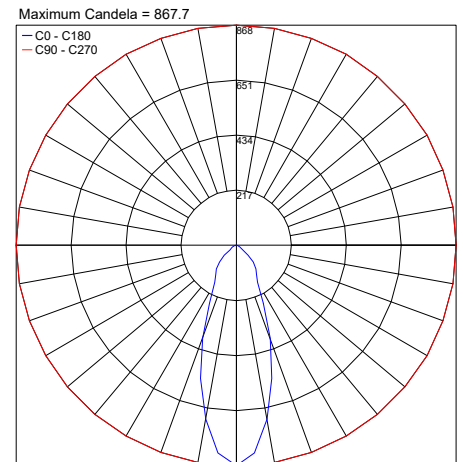

PHOTOMETRIC FILENAME : 200CENT FIX TRIMLESS 6.2W 36".IES

Job Name/Date:

Fixture Type Designation: