

# 200CENT SERIES

## W30 FIXED RECESSED TRIMLESS

Tiny, powerful, exceptional color? It's possible with the 200Cent Series. At just 1.02" (26 mm), the aperture is the same size as a 2 Euro coin, hence its name. Available in a vast array of options (fixed, adjustable, trimless, trimmed, pendant) the 200Cent series has a fixture for every application.



Ceiling Cut-Out: 4.49" x 5.28"  
Fixture Dimensions

### TECHNICAL DATA

<b>Wattage / Input</b>	3W (1050mA), 5.9W (700mA), 6.2W (250mA)
<b>Power Supply</b>	Remote, not included. See page 2.
<b>Construction</b>	Fixture: Aluminum Body: CALCYT®
<b>CCT</b>	2200K, 2400K (only available on the 6.2W version), 2700K, 3000K, 4000K
<b>CRI</b>	>92
<b>Delivered Lumens</b>	201 lm (3W, 3000K, 12°); 393 lm (5.9W, 3000K, 24°); 467 lm (6.2W, 3000K, 36°)
<b>Luminaire Efficacy</b>	67 lm/W (3W); 63 lm/W (5.9W); 75 lm/W (6.2W)
<b>Optics</b>	12° (3W version); 24° (5.9W version) 36° (6.2W version) on Fixed 30° Asymmetric Tilt
<b>Finishes</b>	5 Standard. See below and page 2.
<b>Cut-Out Dimensions</b>	4.49" x 5.28"
<b>Fixture Dimensions</b>	Ø1.42" x h 3.70"
<b>Calcyt® Dimensions</b>	4.33" x 5.12"
<b>Aperture</b>	Ø1.02"
<b>LED Source</b>	1 A+ LED
<b>Color Consistency</b>	2-Step MacAdam
<b>IP Rating</b>	IP20

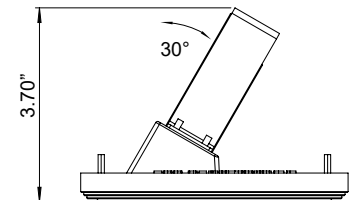
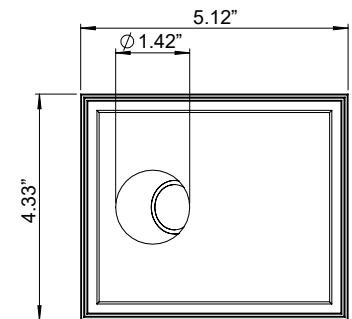

### ORDERING INFORMATION

Example: 511 29 530 200 GOLD. Accessories / Power Supplies ordered separately.

Model No.	CCT	Finish
511 27 (3W - 250LM)	530 - 2200K, 2400K (2400K for the 6.2W version)	200 BLACK - Black
511 28 (5.9W - 500LM)	930 - 2700K	200 WHITE - White
511 29 (6.2W - 750LM)	830 - 3000K	200 CHROME - Chrome
	730 - 4000K	200 GOLD - Gold
		200 COPPER - Copper

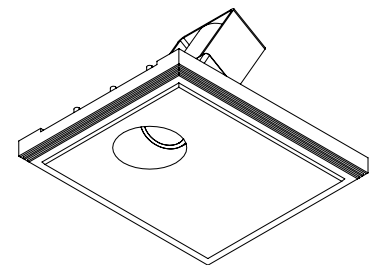

Job Name/Date:

Fixture Type Designation:

# 200CENT SERIES

## W30 FIXED RECESSED TRIMLESS

### SUGGESTED POWER SUPPLIES

1050mA - 3W version (250LM)

Part Number	Description	Input/Output	# of Fixtures
<a href="#">PPLT00466-P</a>	0-10V Dimming to 1.0%	120-277VAC to 1050mA, 10W Class 2	1-2
<a href="#">PPLT00465-P</a>	0-10V Dimming to 1.0%	120-277VAC to 1050mA, 20W Class 2	1-6
<a href="#">PPLT00480-P</a>	0-10V Dimming to 1.0%	120-277VAC to 1050mA, 30W Class 2	1-10
<a href="#">PPLT00309-P</a>	0-10V Dimming to 1.0%	120-277VAC to 1050mA, 50W Class 2	1-16
<a href="#">PPLT00538-P</a>	0-10V Dimming to 0.1% (4 channels)	120-277VAC to 1050mA, 100W Class 2	1-8 (1-32)

700mA - 5.9W version (500LM)

Part Number	Description	Input/Output	# of Fixtures
<a href="#">PPLT00466-P</a>	0-10V Dimming to 1.0%	120-277VAC to 700mA, 10W Class 2	1-1
<a href="#">PPLT00470</a>	Phase Dim (120V Only)	120-277VAC to 700mA, 14W Class 2	1-2
<a href="#">PPLT00465-P</a>	0-10V Dimming to 1.0%	120-277VAC to 700mA, 20W Class 2	1-3
<a href="#">PPLT00261</a>	Leading / Trailing-Edge Dimming to 10% (120V only)	120-277VAC to 700mA, 32W Class 2	3-5
<a href="#">PPLT00467-P</a>	0-10V Dimming to 1.0%	120-277VAC to 700mA, 50W Class 2	1-6
<a href="#">PPLT00538-P</a>	0-10V Dimming to 0.1% (4 channels)	120-277VAC to 700mA, 100W Class 2	1-4 (1-16)

Suggested Lutron Compatible - 700mA - 5.9W version (500LM)

Part Number	Option	Lutron SKU	Dim Range	Description	Input/Output	# of Fixtures
<a href="#">PPLT00515</a>	L3DAE / L3DA3W	L3DA	100%-1%	Hi-Lume™ 1% EcoSystem™ or 1% 3-Wire LED Driv.	120-277VAC to 700mA, 14W, Class 2	1-2
<a href="#">PPLT00517</a>	L3DAE / L3DA3W	L3DA	100%-1%	Hi-Lume™ 1% EcoSystem™ or 1% 3-Wire LED Driv.	120-277VAC to 700mA, 27W, Class 2	2-4
<a href="#">PPLT00181</a>	L3DAE / L3DA3W	L3DA	100%-1%	Hi-Lume™ 1% EcoSystem™ or 1% 3-Wire LED Driv.	120-277VAC to 700mA, 38W, Class 2	4-5

250mA - 6.2W version (750LM)

Part Number	Description	Input/Output	# of Fixtures
<a href="#">PPLT00466-P</a>	0-10V Dimming to 1.0%	120-277VAC to 250mA, 10W Class 2	1-1
<a href="#">PPLT00290</a>	Leading / Trailing Edge Dimming to 10% (120V Only)	120-277VAC to 250mA, 16W Class 2	1-1
<a href="#">PPLT00465-P</a>	0-10V Dimming to 1.0%	120-277VAC to 250mA, 20W Class 2	1-2
<a href="#">PPLT00467-P</a>	0-10V Dimming to 1.0%	120-277VAC to 250mA, 50W Class 2	1-2
<a href="#">PPLT00538-P</a>	0-10V Dimming to 0.1% (4 channels)	120-277VAC to 250mA, 100W Class 2	1-2 (1-8)

For other power supply options consult factory.

Job Name/Date:

Fixture Type Designation:

# 200CENT SERIES

## W30 FIXED RECESSED TRIMLESS

### REQUIRED ACCESSORIES - Installation

**STANDARD** (included)  
installation system for ceiling 0.35" - 0.47" - 0.59"

*Consult factory for optional housing ordering information.*

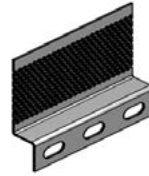

**200 99 025**  
(Set of 2) for ceiling 0.98"

**200 99 030**  
(Set of 2) for ceiling 1.18"

### FINISHES



### PHOTOMETRIC DATA

*Note: All photometry is 3000K*

Maximum Candela = 2823.3

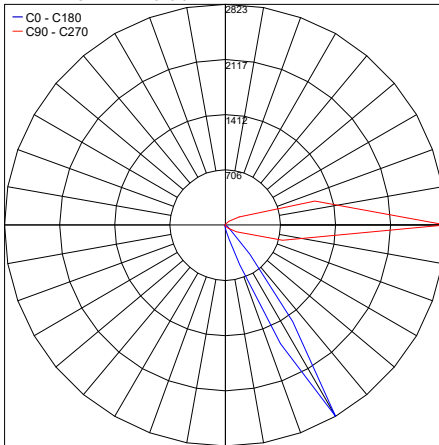

PHOTOMETRIC FILENAME : 200CENT W30 WALLWASH 30° 3W 12° IES

Maximum Candela = 1705

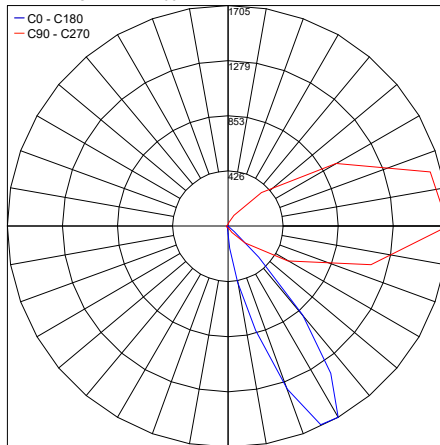

PHOTOMETRIC FILENAME : 200CENT W30 WALLWASH 30° 5.9W 24° IES

Maximum Candela = 799.1

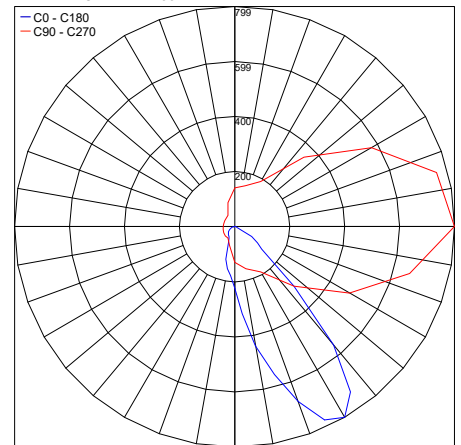

PHOTOMETRIC FILENAME : 200CENT W30 WALLWASH 30° 6.2W 36° IES

Job Name/Date:

Fixture Type Designation: