

BERICA 3.0

Berica is a family of single- or double-beam, indoor, wall-mounted fixtures that can discreetly blend into the wall on which it is installed - or can disappear completely if the primer finish is chosen. Berica is available in 3 sizes and 3 different styles of cover - convex, flat and concave. Berica 3.0 is a concave 4.7" version available in 3 color temperatures and 5 standard finishes.



ADA Compliant

TECHNICAL DATA

Wattage	6W per beam
Power Supply	Integral 120VAC & 277VAC - 0-10V Dimming OR Integral 120VAC Only - Triac and ELV Dimming
Construction	Body/Cover: Anticorodal Aluminum
CCT	2700K, 3000K, 4000K
CRI	>90
Delivered Lumens	341 lm per beam (3000K, Diffuse)
Efficacy	56.8 lm/W per beam (3000K, Diffuse)
Optics	4 Standard, see below
Finishes	5 Standard, see below
Fixture Dimensions	4.72" l x 4.72" w x 1.46" h
Fixture Weight	0.77 lbs
LED Source	8 Mid Power LEDs per beam
Lumen Maintenance	L80, B10 >50,000hrs (Ta 25°C)
Color Consistency	3-step MacAdam
Operating Temp.	32°F to +113°F
IP Rating	IP40

Fixture Dimensions

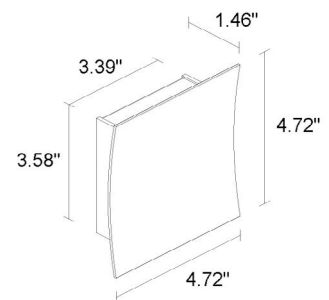

ORDERING INFORMATION

Example: **BB301010005KW8**.

	1000			
Model No.	CRI	CCT	Optics	Finish
BB3010 - Double Beam BB3011 - Single Beam	1000 - CRI>90	F - 2700K 5 - 3000K 9 - 4000K	LW - 45°x96° KW - 59°x90° 0A - Asymmetrical 0D - Diffuse	Z - Antique Bronze 6 - Antique White K - Matte Aluminum Gray 8 - Primer B - White

Job Name/Date:

Fixture Type Designation:

PHOTOMETRIC DATA

Note all Photometry is 3000K

Maximum Candela = 232.7

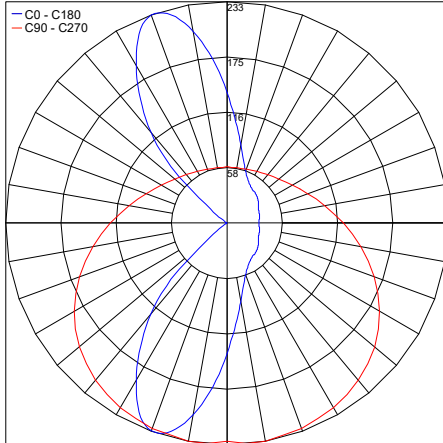

PHOTOMETRIC FILENAME : BERICA 3.0 Double A [3000K 8W].IES

Maximum Candela = 141.2

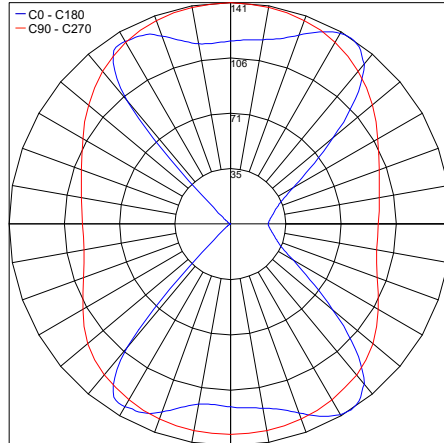

PHOTOMETRIC FILENAME : BERICA 3.0 Double D [3000K 8W].IES

Maximum Candela = 188.2

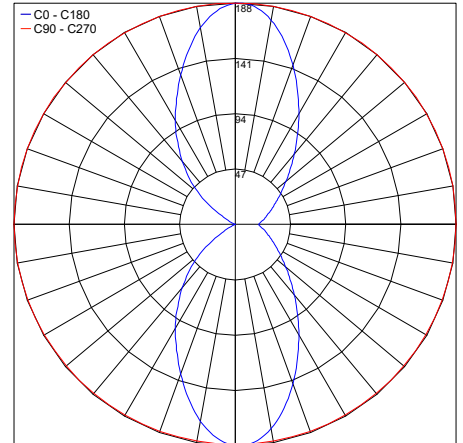

PHOTOMETRIC FILENAME : BERICA 3.0 Double K 59°X90° [3000K 8W].IES

Maximum Candela = 223.8

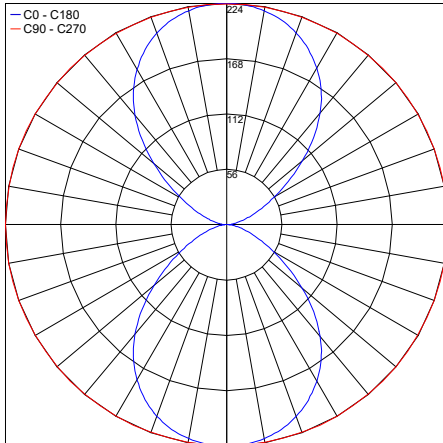

PHOTOMETRIC FILENAME : BERICA 3.0 Double L 45°X96° [3000K 8W].IES

Maximum Candela = 232.7

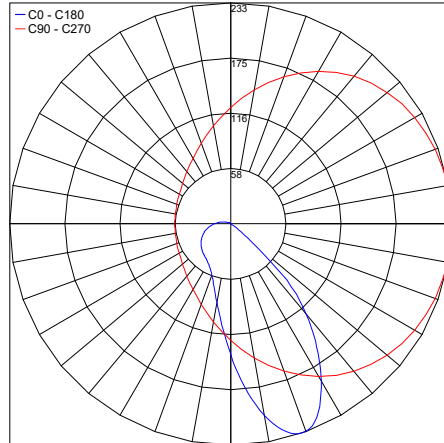

PHOTOMETRIC FILENAME : BERICA_IN_3.0_Single_A_3000K_5W.IES

Maximum Candela = 141.2

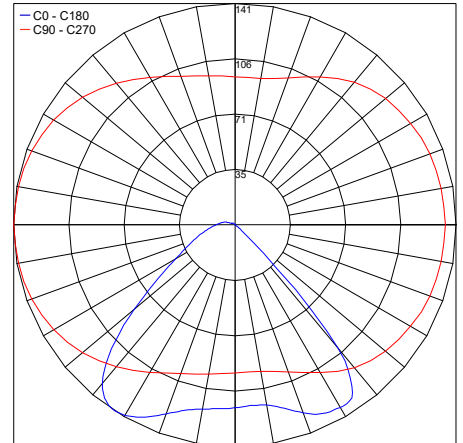

PHOTOMETRIC FILENAME : BERICA_IN_3.0_Single_D_3000K_5W.IES

Maximum Candela = 188.2

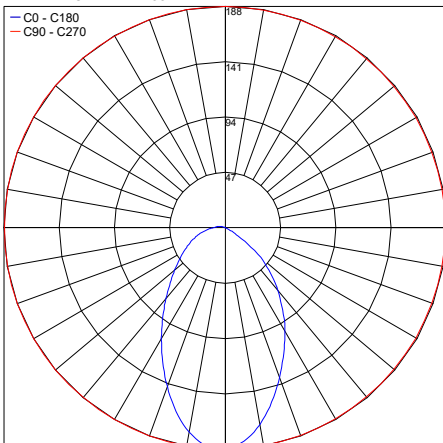

PHOTOMETRIC FILENAME : BERICA_IN_3.0_Single_K_59X90_3000K_5W.IES

Maximum Candela = 223.4

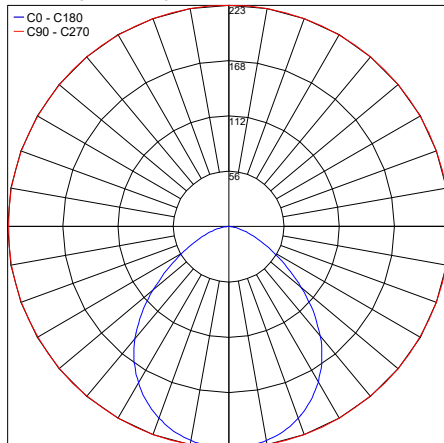

PHOTOMETRIC FILENAME : BERICA_IN_3.0_Single_L_45X96_3000K_5W.IES

Job Name/Date:

Fixture Type Designation: