

Designed for visual comfort, the Bitpop family of low-glare luminaires comes in five different configurations. Ideal for both commercial and residential installations, Bitpop fixtures can be flush or regress mounted. JA8, IC, Chicago Plenum rated.



JA8-2016



Ceiling Cut-Out: 3.23" x 3.23"
Fixture Dimensions

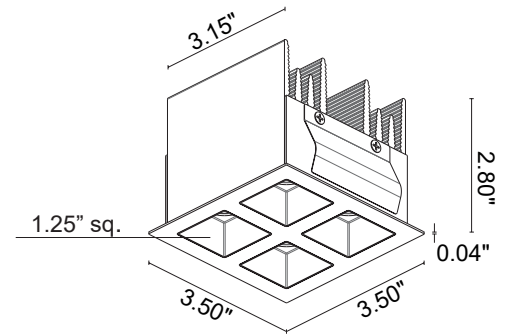

TECHNICAL DATA

Wattage / Input	24W (500mA)
Power Supply	Remote, not included. See page 2.
Construction	Body: Aluminum Alloy EN AW 6082 Trim: Steel Cable Length: 0.98' standard
CCT	2700K, 3000K, 4000K
CRI	2700K, 3000K: CRI >90 4000K: CRI >80 (Not JA8 Certified)
Delivered Lumens	1340 lm (3000K, 30°, CRI 90)
Efficacy	52 lm/W
Optics	17° (Not JA8 Certified), 30°, 42°, 17°x45°
Finishes	3 Standard, Custom RAL (see below)
Cut-Out Dimensions	3.23" x 3.23"
Fixture Dimensions	3.50" x 3.50" x 2.80"
Aperture	1.25" sq. x 4 cell
Fixture Weight	0.93 lbs
LED Source	1 High-Intensity Power LED
Lumen Maintenance	L85,B10>50,000hrs (Ta 25°C)
Color Consistency	3-Step MacAdam
Operating Temp.	32°F to +113°F
IP Rating	IP40 / IP44 Installed
JA8	Certified

ORDERING INFORMATION

Example: **BP221109SB0**. Accessories / Power Supplies ordered separately.

BP2211			
Model No.	CRI / CCT	Optics	Finish (Trim / Reflector)
BP2211	1F - 90 CRI, 2700K 15 - 90 CRI, 3000K 09 - 80 CRI, 4000K (CRI>80 - not JA8 Certified)	S - 17° (Not JA8 Certified) F - 30° L - 42° W - 17° x 45°	B0 - Black / White N0 - Black / Black W0 - White / White C - Custom RAL (consult factory for "C")

Job Name/Date:

Fixture Type Designation:

SUGGESTED POWER SUPPLIES

JA8 Compatible (Also for General Use)

Part Number	Description	Input/Output	# of Fixtures
PPLT00308-P	0-10V Dimming (to 0.1%)	120-277VAC to 500mA, 30W, Class 2	1-1
PPLT00480-P	0-10V Dimming (to 1.0%)	120-277VAC to 500mA, 30W, Class 2	1-1

SUGGESTED POWER SUPPLIES

500mA (Not JA8 Compatible)

Part Number	Description	Input/Output	# of Fixtures
PPLT00309-P	0-10V Dimming (to 0.1%)	120-277VAC to 500mA, 50W, Class 2	1-1
PPLT00467-P	0-10V Dimming (to 1.0%)	120-277VAC to 500mA, 50W, Class 2	1-1
PPLT00538-P	0-10V Dimming (to 0.1%)	120-277VAC to 500mA, 100W, Class 2	1-4

Suggested Lutron Compatible (Not JA8 Compatible)

Part Number	Option	Lutron SKU	Dim Range	Description	Input/Output	# of Fixtures
PPLT00180	L3DAE / L3DA3W	L3DA	100%-1%	Hi-Lume™ 1% EcoSystem™ / 1% 3-Wire LED Driver	120-277VAC to 500mA, 27W, Class 2	1-1

For other power supply options consult factory.

ACCESSORIES

Installation - Regress Mount (non IC, Chicago Plenum)

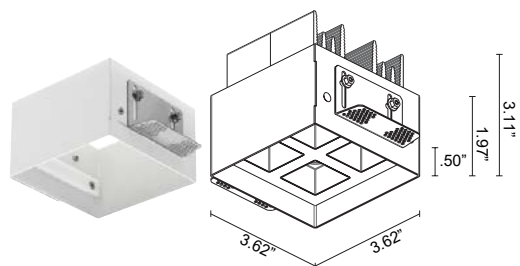

WC8704 - White

WC8704N - Black

Outer Casing for recessed installation in ceilings

REQUIRED for Regress Mount Option.

IC Rated, Chicago Plenum, JA8 (non regress - flange)

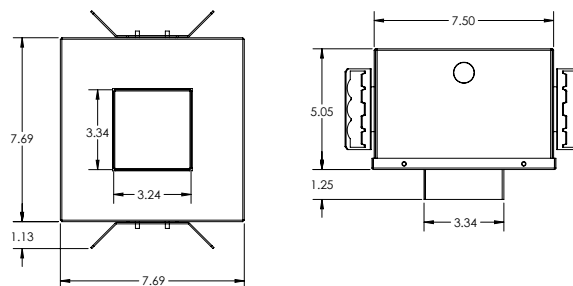

AH-0004-CP - Chicago Plenum or JA8 Rated

AH-0004-IC - IC Rated

Outer Casing for recessed installation in ceilings.

Job Name/Date:

Fixture Type Designation:

PHOTOMETRIC DATA

S - 17°

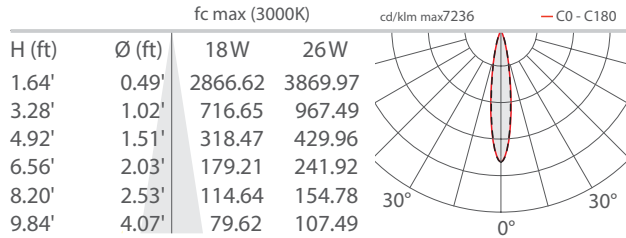

F - 30°

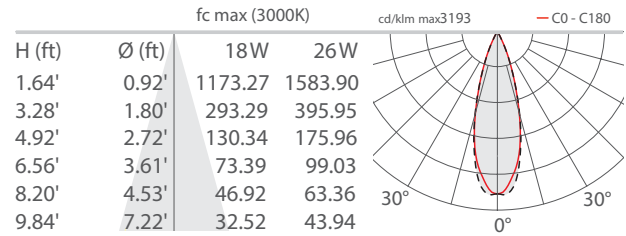

L - 42°

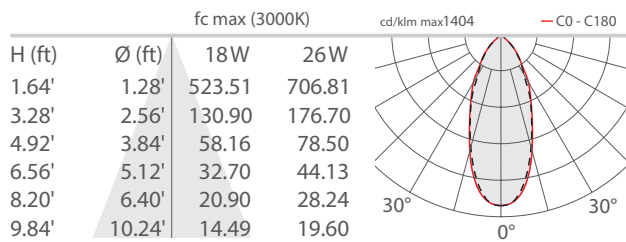

W - 17° x 45°

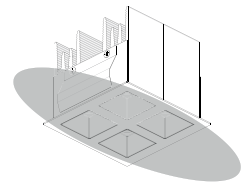
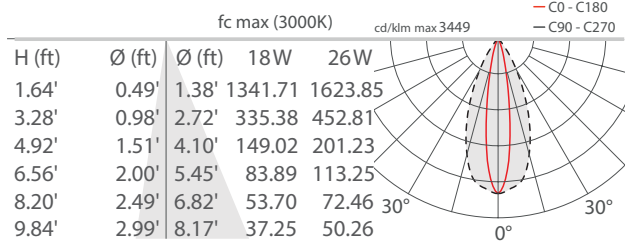

Job Name/Date:

Fixture Type Designation: