

BRIGHT 2.8

The Bright 2 series are small, powerful and versatile fixtures. Available in numerous optics, styles and anti-glare accessories, this fixture can be installed in-grade, wall mount or ceiling mount. Can also be pressure washed for easy maintenance. **The Bright 2, Smoothy 2 and Litus 2 series all use the same LED.**

TECHNICAL DATA

Wattage / Input	2.5W, 3.5W (24VDC)
Power Supply	Remote, not included. See page 2.
Construction	Body: Anodized Aluminum EN AW 6082 Trim: Aluminum/Stainless Steel Lens: Tempered Transparent Glass Cable Length: 4.92' standard
CCT	2700K, 3000K, 4000K, Blue (3500K on request)
CRI	>80
BUG Rating	B0-U2-G0 (3000K, 2.5W, P) B0-U3-G0 (3000K, 2.5W, S, M, L, Q, W) B0-U3-G0 (3000K, 3.5W, All optics)
Delivered Lumens	112 lm (3000K, 20°, 2.5W) 143 lm (3000K, 20°, 3.5W)
Efficacy	44.8 lm/W (3000K, 20°, 2.5W) 40.9 lm/W (3000K, 20°, 3.5W)
Optics	6 Standard (see below)
Finishes	Gray, Stainless Steel
Fixture Dimensions	Ø3.35" x 2.60" h
Cut-out Size	Ø2.76" (for ceiling or wall installations)
Fixture Weight	1.10 lbs SS, 0.88 lbs Aluminum
LED Source	1 Power LED
Lumen Maintenance	L90, B10 >50,000hrs (Ta 25°C)
Color Consistency	1/4 ANSI BIN
Operating Temp.	-4°F to +113°F
IP Rating	IP68, IP69 (Tested to EN / IEC 60598-1)
IK Rating	IK10



Cutout Dimensions for ceiling/wall installations with fixing spring = Ø2.76"

Fixture Dimensions

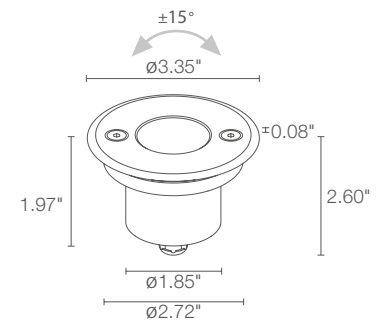

ORDERING INFORMATION

Example: CB28000FMF or CB28000FMF-0. Accessories / Power Supplies ordered separately.

CB280					
Model No.	Wattage	CCT	Optics	Finish	Cable Length
CB280	00 - 2.5W 10 - 3.5W	F - 2700K 5 - 3000K 9 - 4000K 1 - Blue	S - 8° tiltable ±15° M - 20° tiltable ±15° P - 36° tiltable ±15° L - 41° tiltable ±15° Q - 68° tiltable ±15° W - 10° x 44° tiltable ±15°	F - Gray I - Stainless Steel	4.92' standard 1 - 16.40' 2 - 32.81' 3 - 49.21' 4 - 65.62'

Job Name/Date:

Fixture Type Designation:

SUGGESTED POWER SUPPLIES

24VDC

Part Number	Description	Input/Output	# of Fixtures	
			2.5W	3.5W
PPLT00632	0-10V Dimming (Dim to Off)	120-277VAC to 24VDC, 12W, Class 2	1-3	1-2
PPLT00056	Non-Dim	120-277VAC to 24VDC, 26W, Class 2, IP66	1-8	1-5
PPLT00586	Non-Dim	120-277VAC to 24VDC, 40W, Class 2	1-12	1-9
PPLT00158	Non-Dim	120VAC to 24VDC, 100W, Class 2	1-32	1-22
PPLT00543	0-10V Dimming to 15% (-40°C / -40°F cold weather start)	120-277VAC to 24VDC, 100W, Class 2	4-32	3-22

Suggested Lutron Compatible

Part Number	Option	Lutron SKU	Dim Range	Description	Input/Output	# of Fixtures	
						2.5W	3.5W
PPLT00273	L3DAE / L3DA3W	L3DA	100%-1%	Hi-Lume™ 1% EcoSystem™ or 1% 3-Wire LED Driver	120-277VAC to 24VDC, 40W, Class 2	1-12	1-9
PPLT00530	L3DAE / L3D0	L3DA/L3D0	100%-1%	Hi-Lume™ 0.1% EcoSystem™ or 3-Wire LED Driver	120-277VAC to 24VDC, 96W, Class 2	1-30	1-21

For other power supply options consult factory.

ACCESSORIES - Installation

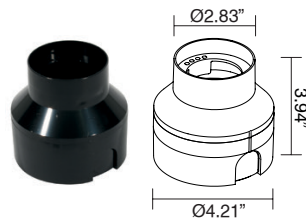

WC0103
Outer Casing
For in-grade use

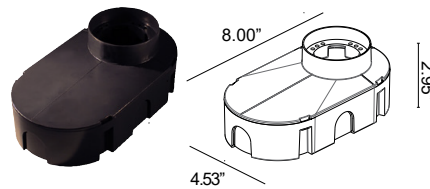

WC0150
Outer Casing
For in-grade use



WG0100
Fixing Spring
For ceiling/wall use

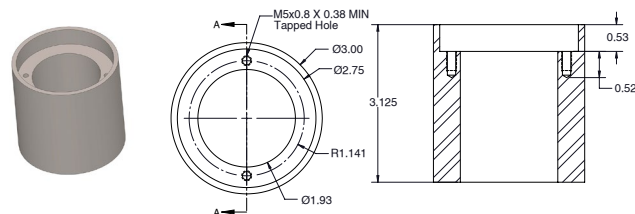

PPMP03088
Core Drilled Application Sleeve

Anti-glare

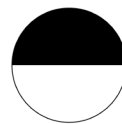

WE0400S
Anti-glare lens, half transparent and half serigraphed black

Job Name/Date:

Fixture Type Designation:

PHOTOMETRIC DATA

Note all Photometry is 3000K

S - 8°

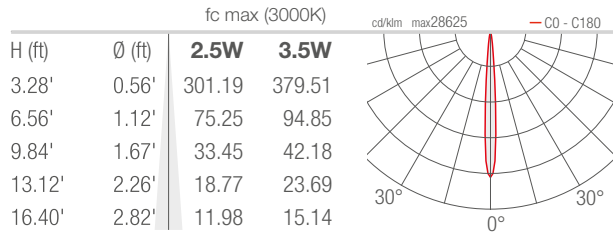

M - 20°

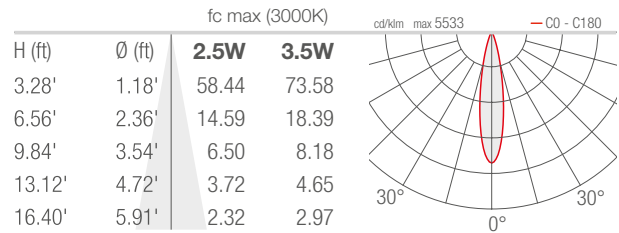

P - 36° sharp

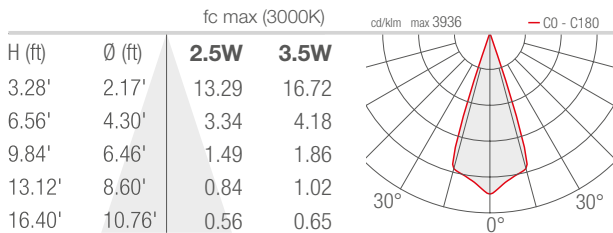

L - 41°

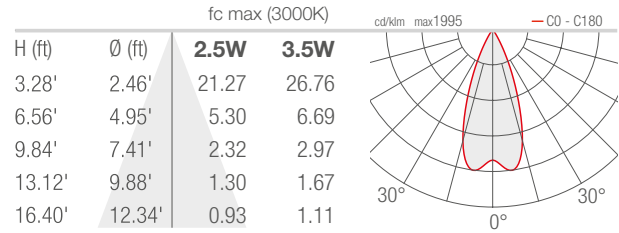

Q - 68° sharp

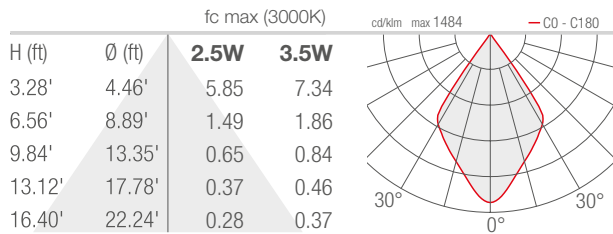

W - 10°x44°

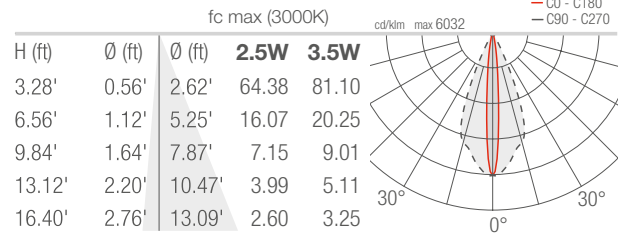

Job Name/Date:

Fixture Type Designation: