

# BRIGHT 2.9

The Bright 2 series are small, powerful and versatile fixtures. Available in numerous optics, styles and anti-glare accessories, this fixture can be installed in-grade, wall mount or ceiling mount. Suitable for power washing. **The Bright 2, Smoothy 2 and Litus 2 series all use the same LED.**

## TECHNICAL DATA

<b>Wattage / Input</b>	2.5W, 3.5W (24VDC)
<b>Power Supply</b>	Remote, not included. See page 2.
<b>Construction</b>	Body: Anodized Aluminum EN AW 6082 Lens: Tempered Transparent Glass Cable Length: 4.92' standard
<b>CCT</b>	2700K, 3000K, 4000K, Blue (3500K on request)
<b>CRI</b>	>80
<b>BUG Rating</b>	B0-U2-G0 (3000K, 2.5W, P) B0-U3-G0 (3000K, 2.5W, S, M, L, Q, W) B0-U3-G0 (3000K, 3.5W, All optics)
<b>Delivered Lumens</b>	112 lm (3000K, 20°, 2.5W) 143 lm (3000K, 20°, 3.5W)
<b>Efficacy</b>	44.8 lm/W (3000K, 20°, 2.5W) 40.9 lm/W (3000K, 20°, 3.5W)
<b>Optics</b>	6 Standard (see below)
<b>Finishes</b>	Micro-blasted Stainless Steel
<b>Fixture Dimensions</b>	3.35" l x 3.35" w x 2.36" h
<b>Cut-out Size</b>	Ø2.76" (for ceiling or wall installations)
<b>Fixture Weight</b>	1.10 lbs SS, 0.88 lbs Aluminum
<b>LED Source</b>	1 Power LED
<b>Lumen Maintenance</b>	L90, B10 >50,000hrs (Ta 25°C)
<b>Color Consistency</b>	1/4 ANSI BIN
<b>Operating Temp.</b>	-4°F to +113°F
<b>IP Rating</b>	IP68, IP69 (Tested to EN / IEC 60598-1)
<b>IK Rating</b>	IK10



Cutout Dimensions for ceiling/wall installations with fixing spring = Ø2.76"

Fixture Dimensions

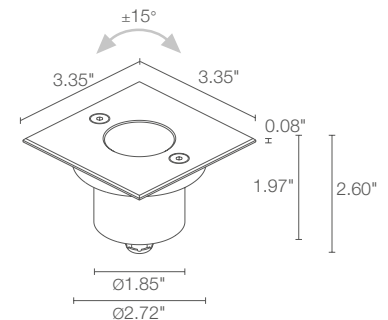

## ORDERING INFORMATION

Example: CB29000FMI or CB29000FMI-3. Accessories / Power Supplies ordered separately.

Model No.	Wattage	CCT	Optics	Finish	Cable Length
CB290	00 - 2.5W 10 - 3.5W	F - 2700K 5 - 3000K 9 - 4000K 1 - Blue	S - 8° tiltable ±15° M - 20° tiltable ±15° P - 36° sharp tiltable ±15° L - 41° tiltable ±15° Q - 68° sharp tiltable ±15° W - 10° x 44° tiltable ±15°	I - Stainless Steel	4.92' standard 1 - 16.40' 2 - 32.81' 3 - 49.21' 4 - 65.62'

Job Name/Date:

Fixture Type Designation:

## SUGGESTED POWER SUPPLIES

24VDC

Part Number	Description	Input/Output	# of Fixtures	
			2.5W	3.5W
<a href="#">PPLT00632</a>	0-10V Dimming (Dim to Off)	120-277VAC to 24VDC, 12W, Class 2	1-3	1-2
<a href="#">PPLT00056</a>	Non-Dim	120-277VAC to 24VDC, 26W, Class 2, IP66	1-8	1-5
<a href="#">PPLT00586</a>	Non-Dim	120-277VAC to 24VDC, 40W, Class 2	1-12	1-9
<a href="#">PPLT00709</a>	ELV / TRIAC & 0-10V Dimming	120-277VAC to 24VDC, 96W, Class 2, DAMP	1-30	1-21
<a href="#">PPLT00543</a>	0-10V Dimming to 15% (-40°C / -40°F cold weather start)	120-277VAC to 24VDC, 100W, Class 2	4-32	3-22

## Suggested Lutron Compatible

Part Number	Option	Lutron SKU	Dim Range	Description	Input/Output	# of Fixtures	
						2.5W	3.5W
<a href="#">PPLT00273</a>	L3DAE / L3DA3W	L3DA	100%-1%	Hi-Lume™ 1% EcoSystem™ or 1% 3-Wire LED Driver	120-277VAC to 24VDC, 40W, Class 2	1-12	1-9
<a href="#">PPLT00530</a>	L3DAE / L3D0	L3DA/L3D0	100%-1%	Hi-Lume™ 0.1% EcoSystem™ or 3-Wire LED Driver	120-277VAC to 24VDC, 96W, Class 2	1-30	1-21

For other power supply options consult factory.

## ACCESSORIES

### Installation



**WC0100**  
Outer Casing  
For in-grade use

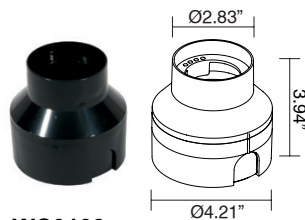

**WC0103**  
Outer Casing  
For in-grade use

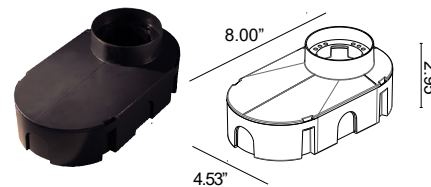

**WC0150**  
Outer Casing  
For in-grade use



**WG0100**  
Fixing Spring  
For ceiling/wall use

### Anti-glare

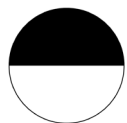

**WE0400S**  
Anti-glare lens, half transparent and half serigraphed black

Job Name/Date:

Fixture Type Designation:

## PHOTOMETRIC DATA

Note all Photometry is 3000K

### S - 8°

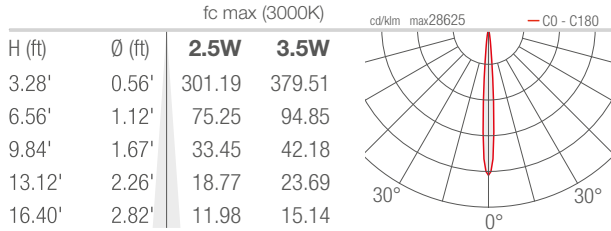

### M - 20°

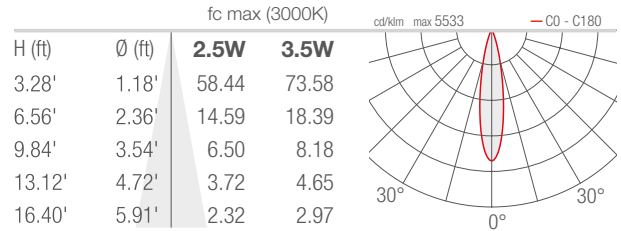

### P - 36° sharp

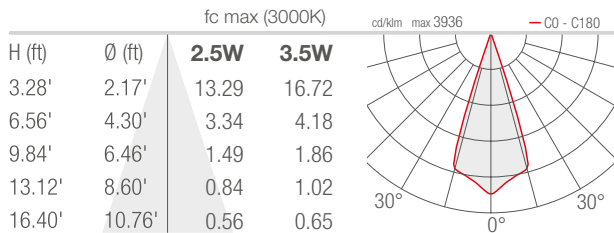

### L - 41°

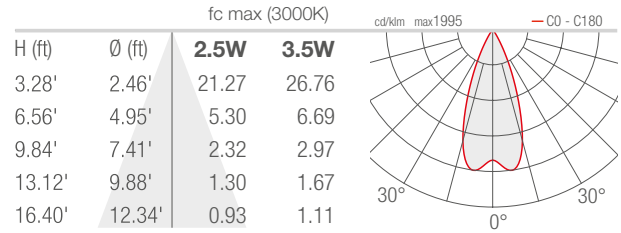

### Q - 68° sharp

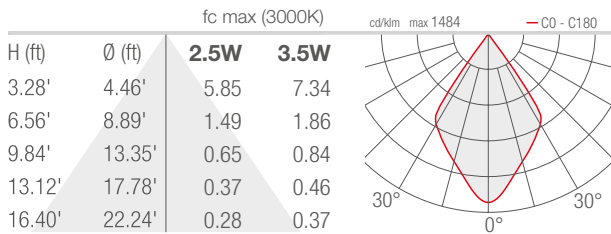

### W - 10°x44°

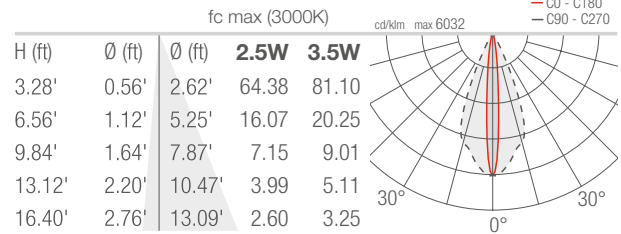

Job Name/Date:

Fixture Type Designation: