

BRIGHT 3.F

The Bright 3.F is a small, powerful IP69K outdoor recessed fixture. It is available in white light with 7 different optics options and can be installed in-grade, wall or ceiling mount. Not suitable for use in swimming pools or fountains. Drive-over rated up to 11,000 lbs. **The Bright 3, Smoothy 5 and Litus 5 series all use the same LED.**

TECHNICAL DATA

Wattage / Input	10W, 13W (24VDC)
Power Supply	Remote, not included. See page 2.
Construction	Body: Anodized Aluminum EN AW 6082 Trim: AISI 316L Stainless Steel Lens: Tempered Serigraphed-Gray and Transparent Extra-Clear Glass Cable Length: 4.92' standard
CCT	2700K, 3000K, 4000K
CRI	>80, >90
BUG Rating	B0-U3-G0 (3000K, 10W, P) B0-U4-G0 (3000K, 10W, S, M, L, K, W, D) B0-U4-G0 (3000K, 13W, S, M, P, W, D) B0-U5-G0 (3000K 13W, L, K)
Delivered Lumens	See Delivered Lumens Chart
Efficacy	84.5-75.9 lm/W (10W), 86.5 lm/W-70.1 (13W)
Optics	7 Standard (see below)
Finishes	Stainless Steel
Fixture Dimensions	Ø4.41" x 2.95" h
Cut-out Size	Ø3.78" (for ceiling or wall installations)
Fixture Weight	1.72 lbs
LED Source	1 COB LED High Density
Lumen Maintenance	L95, B10 >50,000hrs (Ta 25°C)
Color Consistency	3-Step MacAdam
Operating Temp.	-4°F to +113°F
IP Rating	IP68, IP69 (Tested to EN / IEC 60598-1)
IK Rating	IK10



Cut-out Dimensions for ceiling/wall installations with fixing spring = Ø3.78"

Fixture Dimensions

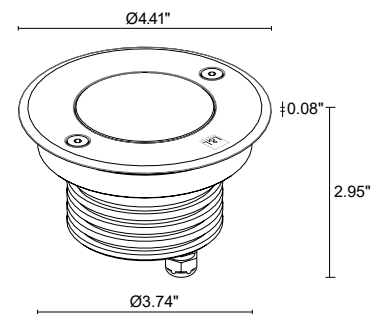

Delivered Lumens (3000K, 55°)	10W	13W
CRI 80	845 lm	1125 lm
CRI 90	759 lm	911 lm

ORDERING INFORMATION

Example: CB3F001000F0M1 or CB3F001000F0M1-1. Accessories / Power Supplies ordered separately.

<input type="text"/>	<input type="text"/>	<input type="text"/>	<input type="text"/>	<input type="text"/>	<input type="text"/>	<input type="text"/>
Model No.	CRI	Optical Accessories	CCT	Optics	Finish	Cable Length
CB3F00 (10W)	0 - CRI>80	000 - None	F0 - 2700K	S - 16°	I - Stainless Steel	4.92' standard
CB3F01 (13W)	1 - CRI>90	010 - Anti-Glare Screen <i>Not available with diffuse optics or compatible with honeycomb louvre.</i>	50 - 3000K	M - 21°		1 - 16.40'
		001 - Honeycomb Louvre <i>Honeycomb Louvre only available with 16°, 21°, 38°, 55° optics</i>	90 - 4000K	L - 38°		2 - 32.81'
		020 - None - Diffuse		K - 55°		3 - 49.21'
				P - 58° sharp		4 - 65.62'
				W - 16°x69°		
				D - Diffuse		

Job Name/Date:

Fixture Type Designation:

SUGGESTED POWER SUPPLIES

24VDC

Part Number	Description	Input/Output	# of Fixtures	
			10W	13W
PPLT00586	Non-Dim	120-277VAC to 24VDC, 40W, Class 2	1-3	1-2
PPLT00543	0-10V Dimming to 15% (-40°C / -40°F cold weather start)	120-277VAC to 24VDC, 100W, Class 2	1-8	1-6

Suggested Lutron Compatible

Part Number	Option	Lutron SKU	Dim Range	Description	Input/Output	# of Fixtures	
						10W	13W
PPLT00530	L3DAE / L3D0	L3DA/L3D0	100%-1%	Hi-Lume™ 0.1% EcoSystem™ or 3-Wire LED Driver	120-277VAC to 24VDC, 96W, Class 2	1-7	1-5

DRIVERS IN NEMA ENCLOSURE

Remote 24VDC - ELV / TRIAC / 0-10V



PPLT00715

Part Number	Description	Input/Output	# of Fixtures	
			10W	13W
PPLT00715	ELV / TRIAC / 0-10V Dimming	120-277VAC to 24VDC, 96W, Class 2, WET/DAMP	1-7	1-5

For other power supply options consult factory.

Job Name/Date:

Fixture Type Designation:

ACCESSORIES

Installation



WC0105
Outer Casing
For in-grade use



WG0400
Fixing Spring
For ceiling/wall use

Anti-glare

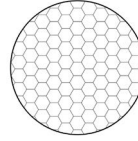

Honeycomb Louvre*
Can be provided on all fixed optics except for the sharp, diffuse and elliptical optics.
*Order together with lighting fixture

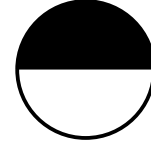

Anti-Glare Screen*
Can be provided on all optics except for diffuse optics.
*Order together with lighting fixture

Other Parts



WE0201
Magnet for 16°x69° adjustable optics

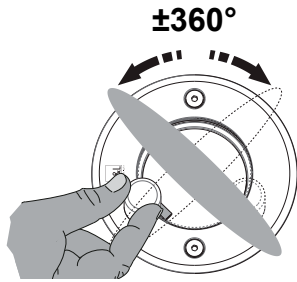

16°, 21°: optical system consisting of a high-efficiency TIR lens combined with a high-quality technical filter, 38°, 55°: optical system consisting of a high-efficiency TIR lens, sharp 58°: SHARP optical system consisting of a plano-convex lens for an extremely well-defined light beam, combined with a high-quality technical filter, 16°x69° adjustable through 360°: optical system consisting of a high-efficiency TIR lens combined with a high-quality elliptical technical filter and integrated with magnetic material for adjusting the ellipsis (patented), diffuse

Job Name/Date:

Fixture Type Designation:

PHOTOMETRIC DATA

Note all Photometry is 3000K

S - 16°

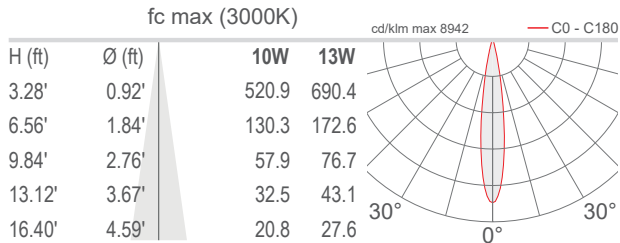

M - 21°

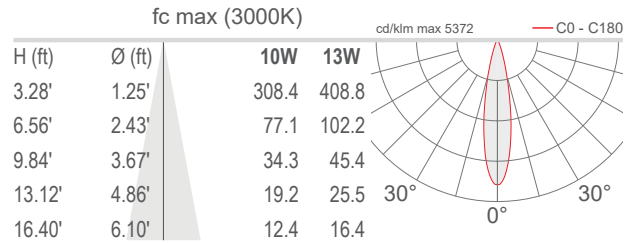

L - 38°

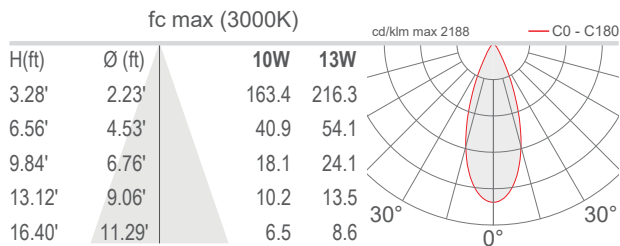

K - 55°

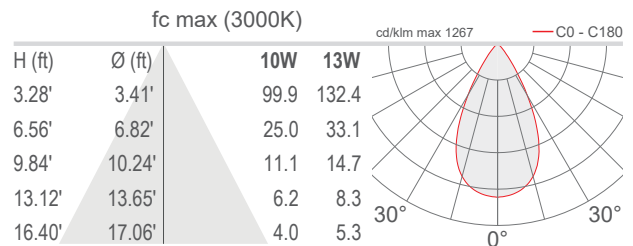

P - 58° Sharp

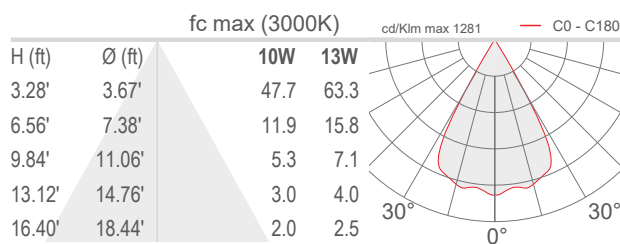

W - 16°x69° Orientabile / Adjustable

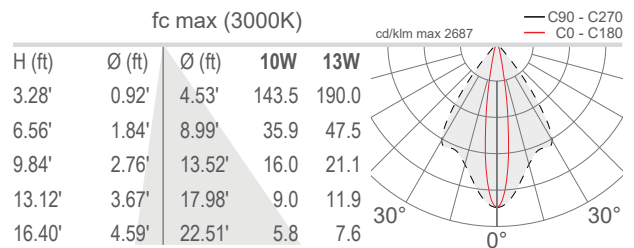

D - Diffuso / Diffuse

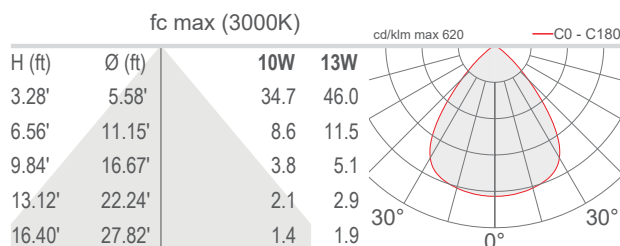

Job Name/Date:

Fixture Type Designation: