

With a depth of only 0.87" the Ciak 1.6 recessed adjustable downlight with snoot is made for the tightest of spaces. With the ability to rotate 350° and 5 optical options it is versatile for a wide array of applications.



Ceiling Cut-Out: Ø1.97"
 Fixture Dimensions
 Ø1.18" x 0.87" h x Ø2.17" outer rim

TECHNICAL DATA

Wattage / Input	2.5W (24VDC)
Power Supply	Remote, not included. See page 2.
Construction	Body/Trim/Snoot: Aluminum Springs: AISI 301 Harmonic Steel Cable Length: 4.92'
CCT	2700K, 3000K, 4000K
CRI	CRI>90
Delivered Lumens	144 lm (3000K, 500mA)
Efficacy	57.6 lm/W
Optics	17°, 29°, 48° sharp, 52°, 16°x34°
Finishes	White, Black, Custom RAL (see below)
Cut-Out Dimensions	Ø1.97"
Fixture Dimensions	Ø1.18" x 0.87" h x Ø2.17" outer rim
Fixture Weight	0.15 lbs
LED Source	1 Power LED
Lumen Maintenance	L90,B10 >50,000hrs (Ta 25°C)
Color Consistency	1/4 ANSI BIN
Operating Temp.	32°F to 113°F
IP Rating	IP40
Impact Rating	—

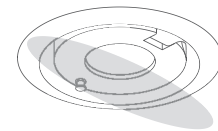
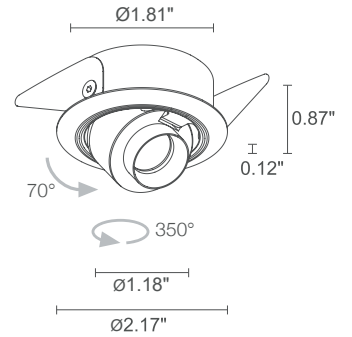

16°x34° optics
 (Ciak 1.1 / 1.7)

ORDERING INFORMATION

Example: CK16001FLN. Accessories / Power Supplies ordered separately.

CK16001			
Model No.	CCT	Optics	Finish
CK16001	F - 2700K 5 - 3000K 9 - 4000K	S - 17° M - 29° P - 48° L - 52° W - 16°x34°	B - White N - Black C - Custom RAL (consult factory for "C")

Job Name/Date:

Fixture Type Designation:

SUGGESTED POWER SUPPLIES

24VDC

Part Number	Description	Input/Output	# of Fixtures
PPLT00275	Non-Dim	120-277VAC to 24VDC, 12W, Class 2, IP66	1-3
PPLT00632	0-10V Dimming (Dim to Off)	120-277VAC to 24VDC, 12W, Class 2	1-3
PPLT00709	ELV / TRIAC & 0-10V Dimming	120-277VAC to 24VDC, 96W, Class 2, DAMP	1-30
PPLT00543	0-10V Dimming to 15% (-40°C / -40°F cold weather start)	120-277VAC to 24VDC, 100W, Class 2	4-32

For other power supply options consult factory.

ACCESSORIES - Installation

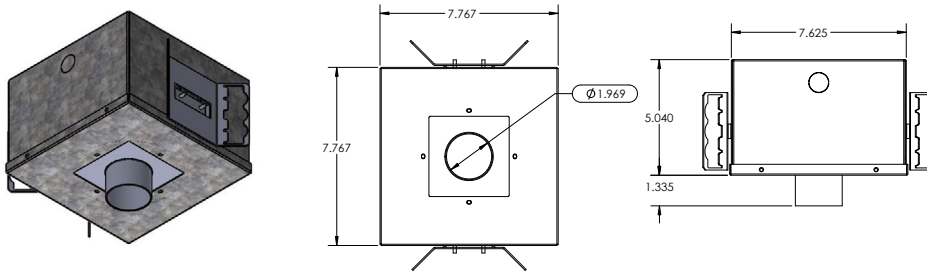

AH-00011-IC (IC Rated)

AH-00011-CP (Chicago Plenum Rated)

Housing for recessed installation in ceilings.

Job Name/Date:

Fixture Type Designation:

PHOTOMETRIC DATA

Note all Photometry is 3000K

S - 17°

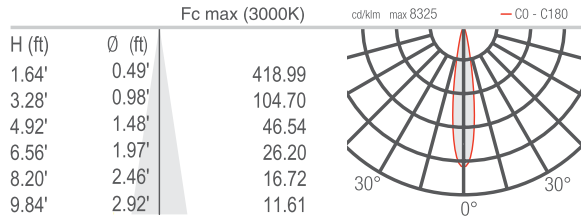

M - 29°

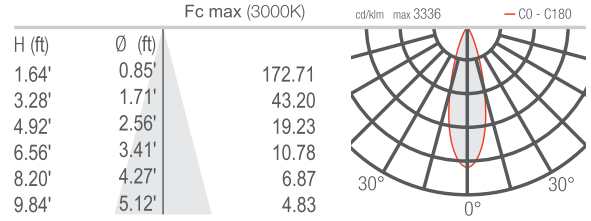

P - 48° sharp

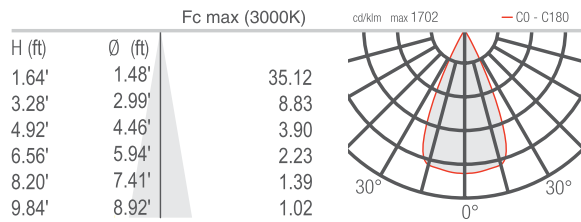

L - 52°

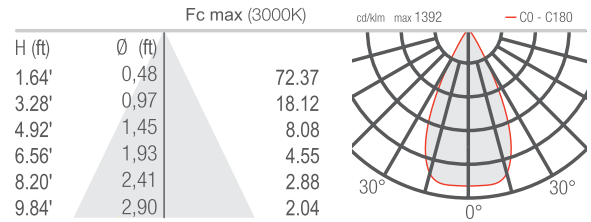

W - 16°x34°

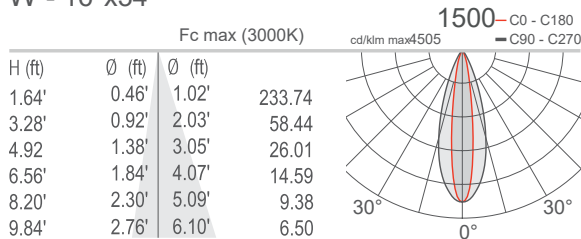

Job Name/Date:

Fixture Type Designation: