

With a depth of only 0.87" the Ciak 1.6 recessed adjustable downlight with snoot is made for the tightest of spaces. With the ability to rotate 350° and 5 optical options it is versatile for a wide array of applications.



Ceiling Cut-Out: Ø1.97"  
 Fixture Dimensions  
 Ø1.18" x 0.87" h x Ø2.17" outer rim

## TECHNICAL DATA

<b>Wattage / Input</b>	2.5W (24VDC)
<b>Power Supply</b>	Remote, not included. See page 2.
<b>Construction</b>	Body/Trim/Snoot: Aluminum Springs: AISI 301 Harmonic Steel Cable Length: 4.92'
<b>CCT</b>	2700K, 3000K, 4000K
<b>CRI</b>	CRI>90
<b>Delivered Lumens</b>	144 lm (3000K, 500mA)
<b>Efficacy</b>	57.6 lm/W
<b>Optics</b>	17°, 29°, 48° sharp, 52°, 16°x34°
<b>Finishes</b>	White, Black, Custom RAL (see below)
<b>Cut-Out Dimensions</b>	Ø1.97"
<b>Fixture Dimensions</b>	Ø1.18" x 0.87" h x Ø2.17" outer rim
<b>Fixture Weight</b>	0.15 lbs
<b>LED Source</b>	1 Power LED
<b>Lumen Maintenance</b>	L90,B10 >50,000hrs (Ta 25°C)
<b>Color Consistency</b>	1/4 ANSI BIN
<b>Operating Temp.</b>	32°F to 113°F
<b>IP Rating</b>	IP40
<b>Impact Rating</b>	—

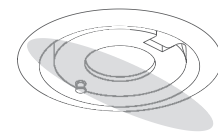
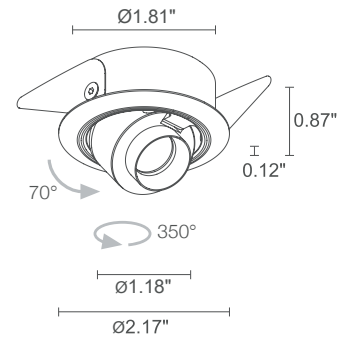

16°x34° optics  
 (Ciak 1.1 / 1.7)

## ORDERING INFORMATION

Example: CK16001FLN. Accessories / Power Supplies ordered separately.

CK16001			
Model No.	CCT	Optics	Finish
CK16001	F - 2700K 5 - 3000K 9 - 4000K	S - 17° M - 29° P - 48° L - 52° W - 16°x34°	B - White N - Black C - Custom RAL (consult factory for "C")

Job Name/Date:

Fixture Type Designation:

## SUGGESTED POWER SUPPLIES

24VDC

Part Number	Description	Input/Output	# of Fixtures
<a href="#">PPLT00275</a>	Non-Dim	120-277VAC to 24VDC, 12W, Class 2, IP66	1-3
<a href="#">PPLT00632</a>	0-10V Dimming (Dim to Off)	120-277VAC to 24VDC, 12W, Class 2	1-3
<a href="#">PPLT00056</a>	Non-Dim	120-277VAC to 24VDC, 26W, Class 2	1-8
<a href="#">PPLT00599</a>	ELV / TRIAC & 0-10V Dimming (100 to 0%)	120-277VAC to 24VDC, 96W, Class 2	1-30
<a href="#">PPLT00284</a>	Non-Dim	120-277VAC to 24VDC, 100W, Class 2, DAMP	1-32
<a href="#">PPLT00543</a>	0-10V Dimming to 15% (-40°C / -40°F cold weather start)	120-277VAC to 24VDC, 100W, Class 2	4-32

For other power supply options consult factory.

## ACCESSORIES - Installation

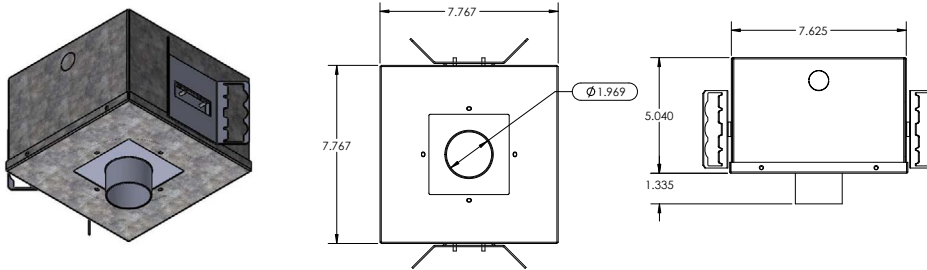

**AH-00011-IC** (IC Rated)

**AH-00011-CP** (Chicago Plenum Rated)

Housing for recessed installation in ceilings.

Job Name/Date:

Fixture Type Designation:

## PHOTOMETRIC DATA

Note all Photometry is 3000K

### S - 17°

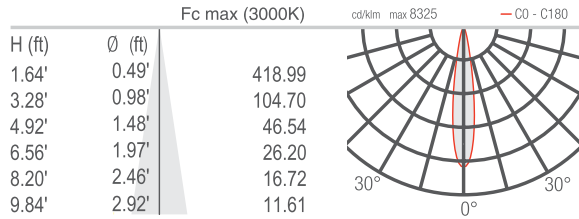

### M - 29°

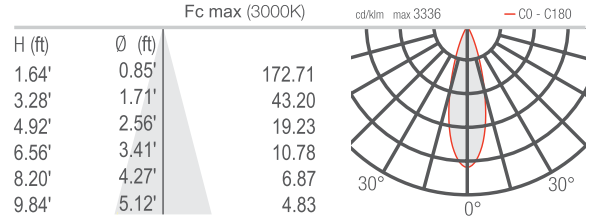

### P - 48° sharp

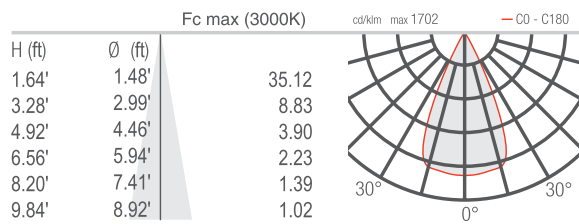

### L - 52°

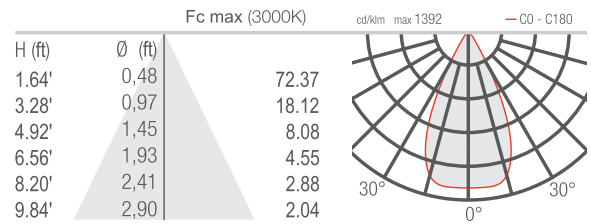

### W - 16°x34°

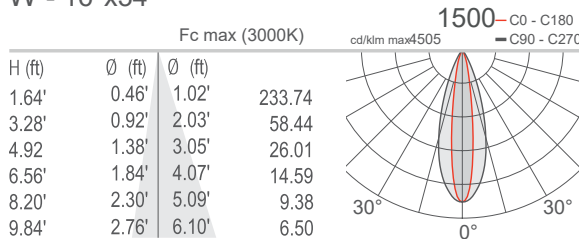

Job Name/Date:

Fixture Type Designation: