

With a depth of only 1.18" the Ciak 2.6 recessed adjustable downlight with snoot can accommodate the tightest of spaces. With 350° rotation and 6 optical options this fixture can be used in a wide array of applications.



## TECHNICAL DATA

<b>Wattage / Input</b>	5W (24VDC)
<b>Power Supply</b>	Remote, not included. See page 2.
<b>Construction</b>	Body/Trim/Snoot: Aluminum Springs: AISI 301 Harmonic Steel Cable Length: 4.92'
<b>CCT</b>	2700K, 3000K, 4000K (3500K on request, consult factory)
<b>CRI</b>	CRI>90
<b>Delivered Lumens</b>	303 lm (3000K, 32°)
<b>Efficacy</b>	60.6 lm/W
<b>Optics</b>	11°, 17°, 19° sharp, 32°, 65°, 13°x43°
<b>Finishes</b>	White, Black, Chrome, Custom RAL (see below)
<b>Cut-Out Dimensions</b>	Ø2.56"
<b>Fixture Dimensions</b>	Ø2.40" x 1.18" h x Ø2.76" outer rim
<b>Fixture Weight</b>	0.33 lbs
<b>LED Source</b>	1 High Intensity Power LED
<b>Lumen Maintenance</b>	L95,B10 >50,000hrs (Ta 25°C)
<b>Color Consistency</b>	3-Step MacAdam
<b>Operating Temp.</b>	32°F to 113°F
<b>IP Rating</b>	IP40
<b>Impact Rating</b>	—

Ceiling Cut-Out: Ø2.56"  
Fixture Dimensions  
Ø2.40" x 1.18" h x Ø2.76" outer rim

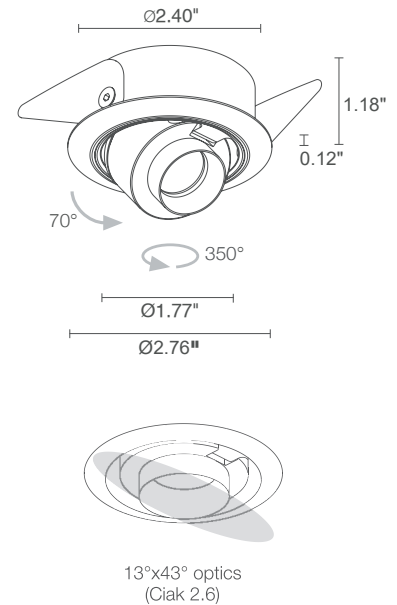

## ORDERING INFORMATION

Example: CK26001FPN. Accessories / Power Supplies ordered separately.

CK26001			
Model No.	CCT	Optics	Finish
CK26001	F - 2700K 5 - 3000K 9 - 4000K	S - 11° M - 17° P - 19° sharp L - 32° J - 65° W - 13°x43°	B - White N - Black C - Chrome R - Custom RAL (consult factory for "C")

Job Name/Date:

Fixture Type Designation:

## SUGGESTED POWER SUPPLIES

24VDC

Part Number	Description	Input/Output	# of Fixtures
<a href="#">PPLT00275</a>	Non-Dim	120-277VAC to 24VDC, 12W, Class 2	1-1
<a href="#">PPLT00632</a>	0-10V Dimming (Dim to Off)	120-277VAC to 24VDC, 12W, Class 2	1-1
<a href="#">PPLT00056</a>	Non-Dim	120-277VAC to 24VDC, 26W, Class 2	1-4
<a href="#">PPLT00284</a>	Non-Dim	120-277VAC to 24VDC, 100W, Class 2	1-16
<a href="#">PPLT00543</a>	0-10V Dimming to 15% (-40°C / -40°F cold weather start)	120-277VAC to 24VDC, 100W, Class 2	2-16

For other power supply options consult factory.

## ACCESSORIES - Installation

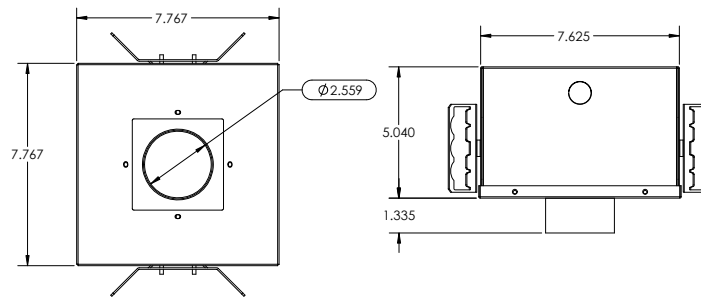
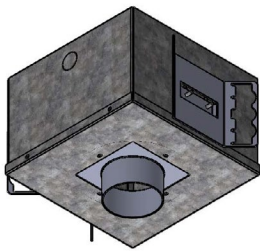

**AH-00010-IC** (IC Rated)

**AH-00010-CP** (Chicago Plenum Rated)

Housing for recessed installation in ceilings.

Job Name/Date:

Fixture Type Designation:

## PHOTOMETRIC DATA

Note all Photometry is 3000K

### S - 11°

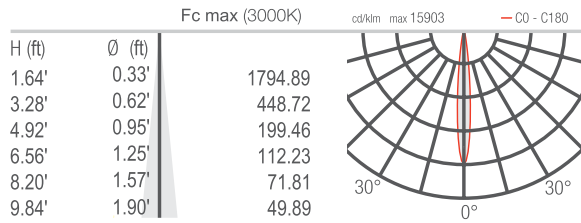

### M - 17°

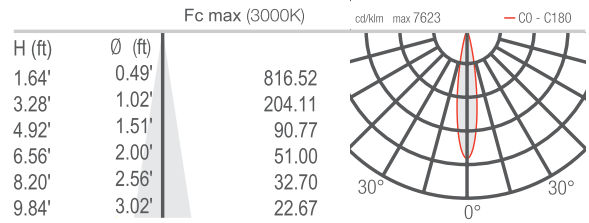

### P - 19° sharp

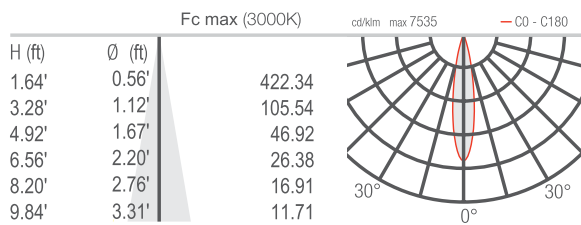

### L - 32°

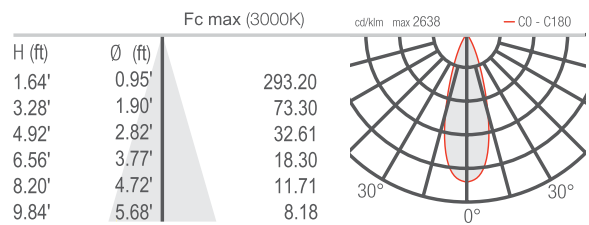

### J - 65°

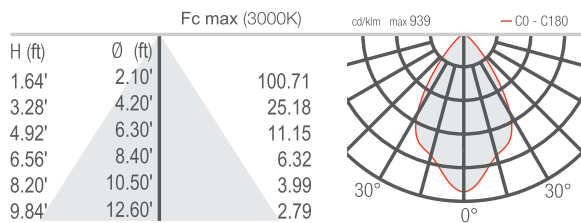

### W - 13°x43°

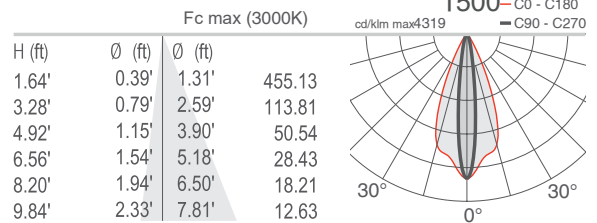

Job Name/Date:

Fixture Type Designation: