

With a depth of only 1.18" the Ciak 2.7 recessed adjustable downlight can accommodate the tightest of spaces. With 350° rotation and 6 optical options this fixture can be used in a wide array of applications.

TECHNICAL DATA

Wattage / Input	5W (24VDC)
Power Supply	Remote, not included. See page 2.
Construction	Body and Trim: Aluminum Springs: AISI 301 Harmonic Steel Cable Length: 4.92'
CCT	2700K, 3000K, 4000K <i>(3500K on request, consult factory)</i>
CRI	CRI>90
Delivered Lumens	303 lm (3000K, 32°)
Efficacy	60.6 lm/W
Optics	11°, 17°, 19° sharp, 32°, 65°, 13°x43°
Finishes	White, Black, Chrome, Custom RAL (see below)
Cut-Out Dimensions	Ø2.56"
Fixture Dimensions	Ø2.40" x 1.18" h x Ø2.76" outer rim
Fixture Weight	0.33 lbs
LED Source	1 High Intensity Power LED
Lumen Maintenance	L95,B10 >50,000hrs (Ta 25°C)
Color Consistency	3-Step MacAdam
Operating Temp.	32°F to 113°F
IP Rating	IP40
Impact Rating	—



Ceiling Cut-Out: Ø2.56"
Fixture Dimensions
Ø2.40" x 1.18" h x Ø2.76" outer rim

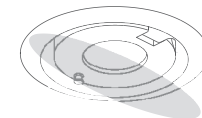
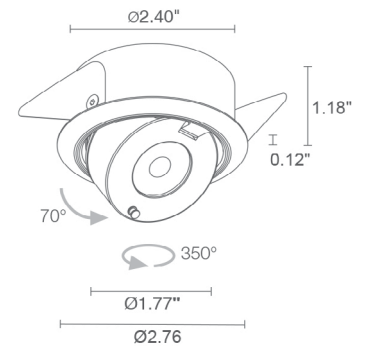

13°x43° optics
(Ciak 2.7)

ORDERING INFORMATION

Example: CK270019LB. Accessories / Power Supplies ordered separately.

CK27001			
Model No.	CCT	Optics	Finish
CK27001	F - 2700K 5 - 3000K 9 - 4000K	S - 11° M - 17° P - 19° sharp L - 32° J - 65° W - 13°x43°	B - White N - Black C - Chrome R - Custom RAL <i>(consult factory for "C")</i>

Job Name/Date:

Fixture Type Designation:

SUGGESTED POWER SUPPLIES

24VDC

Part Number	Description	Input/Output	# of Fixtures
PPLT00275	Non-Dim	120-277VAC to 24VDC, 12W, Class 2	1-1
PPLT00632	0-10V Dimming (Dim to Off)	120-277VAC to 24VDC, 12W, Class 2	1-1
PPLT00056	Non-Dim	120-277VAC to 24VDC, 26W, Class 2	1-4
PPLT00284	Non-Dim	120-277VAC to 24VDC, 100W, Class 2	1-16
PPLT00543	0-10V Dimming to 15% (-40°C / -40°F cold weather start)	120-277VAC to 24VDC, 100W, Class 2	2-16

For other power supply options consult factory.

ACCESSORIES - Installation

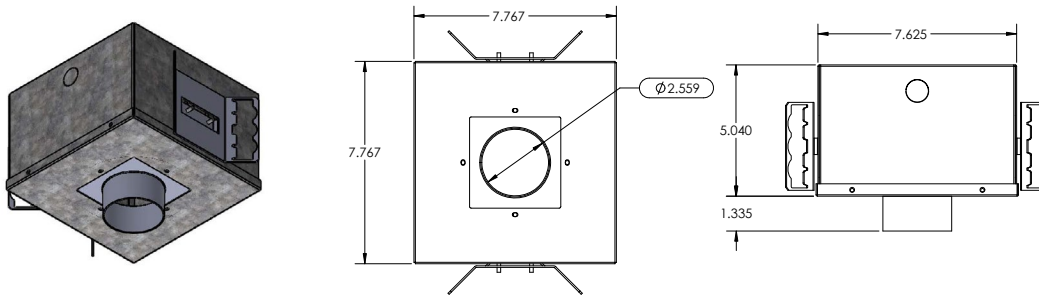

AH-00010-IC (IC Rated)

AH-00010-CP (Chicago Plenum Rated)

Housing for recessed installation in ceilings.

Job Name/Date:

Fixture Type Designation:

PHOTOMETRIC DATA

Note all Photometry is 3000K

S - 11°

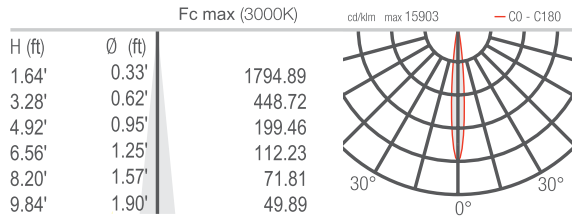

M - 17°

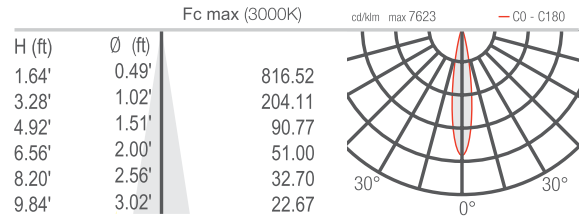

P - 19° sharp

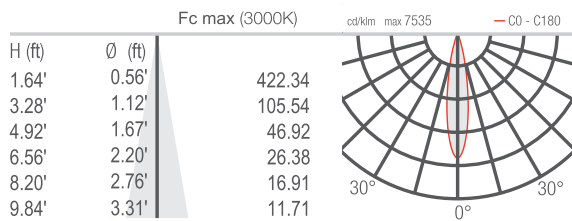

L - 32°

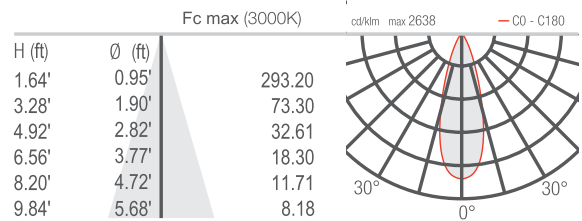

J - 65°

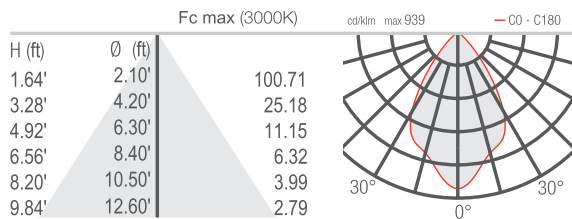

W - 13°x43°

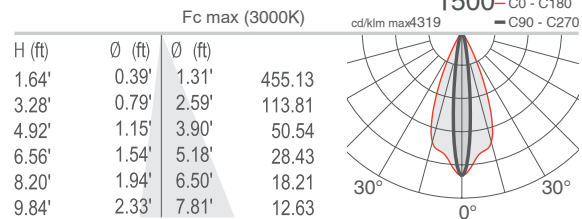

Job Name/Date:

Fixture Type Designation: