

CUBE W

OUTDOOR WALL MOUNTED OPTICS WITH WHITE AND RGB LIGHT

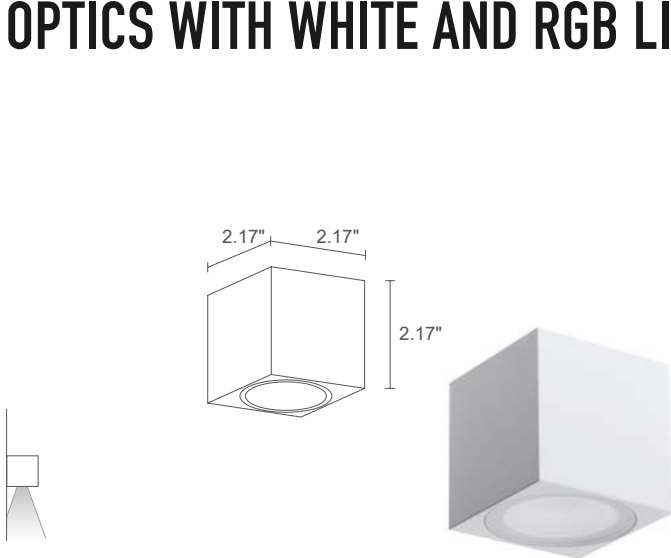

CUBE W 1.0

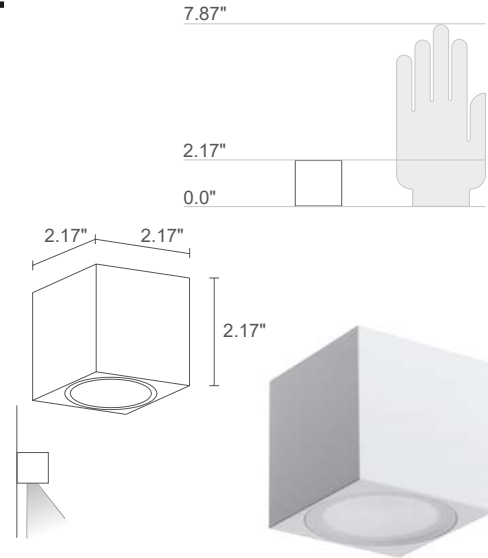

CUBE W 1.1



POWER / MODEL CODE

max 6W max 500mA blue/white light
CU1032 ■ ■ ■ **E** White
CU1032 ■ ■ ■ **H** Anthracite
CU1032 ■ ■ ■ **T** Cor-ten

max 3W max 350mA RGB light
CU1031 6 ■ ■ ■ **E** White
CU1031 6 ■ ■ ■ **H** Anthracite
CU1031 6 ■ ■ ■ **T** Cor-ten

max 6W max 500mA blue/white light
CU1132 ■ ■ ■ **E** White
CU1132 ■ ■ ■ **H** Anthracite
CU1132 ■ ■ ■ **T** Cor-ten

max 3W max 350mA RGB light
CU1131 6 ■ ■ ■ **E** White
CU1131 6 ■ ■ ■ **H** Anthracite
CU1131 6 ■ ■ ■ **T** Cor-ten

■ LED COLOR	F - 2700K 5 - 3000K 9 - 4000K 0 - 5000K 1 - blue
■ OPTICS	S - 18° M - 28° L - 36°

■	F - 2700K 5 - 3000K 9 - 4000K 0 - 5000K 1 - blue
■	S - 18° tilted 20° M - 28° tilted 20° L - 36° tilted 20°

LUMEN OUTPUT AT SOURCE	410 lm (3000K, 500mA) RGB: 197 lm, R: 62 lm G: 100 lm B: 35 lm (350mA)
DELIVERED LUMEN OUTPUT	337 lm (3000K, 500mA, 28°) RGB: 163 lm, R: 51 lm G: 83 lm B: 29 lm (350mA, 28°)
NO. AND TYPE OF LED	3 power LEDs 1/4 ANSI BIN (white LED colour) 50000h L90 B10 (Ta 25°C)
MATERIAL	body in anodized aluminum lens in frosted plexiglass
POWER SUPPLY UNIT	Remote power supply required, not included
POWER CABLES	includes 2x0.98 ft single-core cables RGB: includes 4.92 ft PVC cable FROR 6x0.25 Ø0.20"
WIRING	series
MOUNTING	surface mounted (wall)
NOTES	ceiling-mounted version: Cube C 1.2

LUMEN OUTPUT AT SOURCE	410 lm (3000K, 500mA) RGB: 197 lm, R: 62 lm G: 100 lm B: 35 lm (350mA)
DELIVERED LUMEN OUTPUT	295 lm (3000K, 500mA, 28°) RGB: 141 lm, R: 44 lm G: 72 lm B: 25 lm (350mA, 28°)
NO. AND TYPE OF LED	3 power LEDs 1/4 ANSI BIN (white LED colour) 50000h L90 B10 (Ta 25°C)
MATERIAL	body in anodized aluminum lens in frosted plexiglass
POWER SUPPLY UNIT	Remote power supply required, not included
POWER CABLES	includes 2x0.98 ft single-core cables RGB: includes 4.92 ft PVC cable FROR 6x0.25 Ø0.20"
WIRING	series
MOUNTING	surface mounted (wall)
NOTES	ceiling-mounted version: Cube C 1.3



< **CUBE W 1.0**
3000K, 6W, 36°, white

CUBE C / CUBE W

OUTDOOR CEILING MOUNTED / OUTDOOR WALL MOUNTED

CUBE C 1.2 CUBE W 1.0

S - 18°

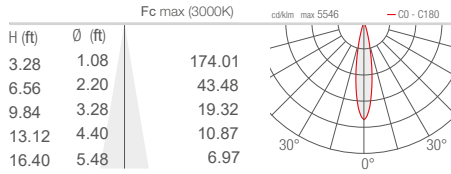

M - 28°

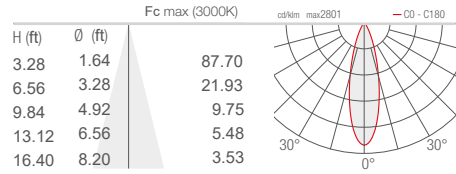

L - 36°

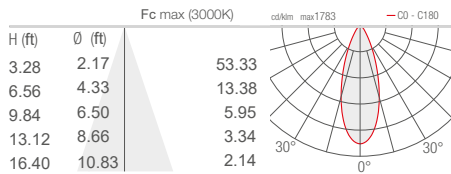

CUBE C 1.3 CUBE W 1.1

S - 18° tilted 20°

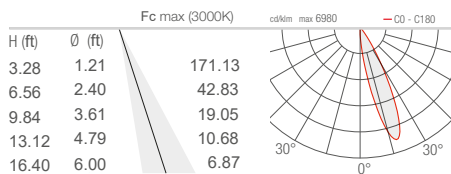

M - 28° tilted 20°

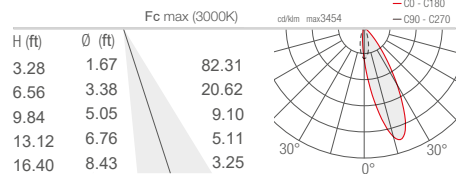

L - 36° tilted 20°

