

DUOMO 2.0

Duomo are a family of adjustable, surface mounted (ceiling, wall, floor) indoor or outdoor floodlights created for architectural lighting of archways, aisles and large spaces. There are 3 different sizes each with an adjustable, sliding bracket that allows the fixture to be custom cantilevered from architectural elements. Duomo 2.0 is available in 3 color temperatures and 8 optics options.



TECHNICAL DATA

Wattage	19W
Power Supply	Remote 24VDC, not included. See page 2.
Construction	Body/Bracket: Anticorodal® Aluminum Lens: Serigraphed, Tempered, Extra-clear Glass
CCT	2700K, 3000K, 4000K
CRI	80, >90
BUG Rating	B2-U1-G0 (All Optics except 63°) B1-U1-G0 (63°)
Delivered Lumens	1428 lm (3000K, 30°, CRI 80) 1322 lm (3000K, 30°, CRI 90)
Efficacy	75.2 lm/W (3000K, 30°, CRI 80) 69.6 lm/W (3000K, 30°, CRI 90)
Optics	8 Standard (see below)
Finishes	3 Standard, Custom RAL (see below)
Fixture Dimensions	1.97" w x 6.14" l x 10.24 h (head 6.54")
Fixture Weight	3.42 lbs
LED Source	4 High Intensity Power LEDs
Lumen Maintenance	L90, B10 >50,000 hrs (Ta 25°C)
Color Consistency	3-Step MacAdam
Operating Temp.	-4°F to +113°F
IP Rating	IP65
IK Rating	IK06

Fixture Dimensions

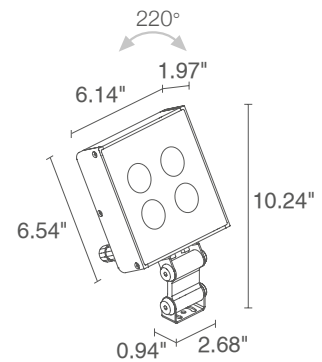

ORDERING INFORMATION

Example: DU2010100190M6. Accessories ordered separately.

DU2010						
Model No.	CRI	Honeycomb Louvre	CCT	Optics		Finish
DU2010	0 - CRI 80 1 - CRI >90	000 - none 001 - honeycomb louvre <i>(not compatible with the 10° optics)</i>	F0 - 2700K 50 - 3000K 90 - 4000K	T - 10° S - 14° M - 30° L - 35°	J - 43° K - 63° W - 18°x44° X - 44°x18°	6 - Antique White E - White H - Anthracite

Job Name/Date:

Fixture Type Designation:

SUGGESTED POWER SUPPLIES

24VDC

Part Number	Description	Input/Output	# of Fixtures
PPLT00056	Non-Dim	120-277VAC to 24VDC, 26W, Class 2, IP66	1-1
PPLT00155	Non-Dim	120VAC to 24VDC, 30W, Class 2	1-1
PPLT00586	Non-Dim	120-277VAC to 24VDC, 40W, Class 2	1-1
PPLT00158	Non-Dim	120VAC to 24VDC, 100W, Class 2	1-4
PPLT00543	0-10V Dimming to 15% (-40°C / -40°F cold weather start)	120-277VAC to 24VDC, 100W, Class 2	1-4

Suggested Lutron Compatible

Part Number	Option	Lutron SKU	Dim Range	Description	Input/Output	# of Fixtures
PPLT00273	L3DAE / L3DA3W	L3DA	100%-1%	Hi-Lume™ 1% EcoSystem™ or 1% 3-Wire LED Driver	120-277VAC to 24VDC, 40W, Class 2	1-1
PPLT00530	L3DAE / L3D0	L3DA/L3D0	100%-1%	Hi-Lume™ 0.1% EcoSystem™ or 3-Wire LED Driver	120-277VAC to 24VDC, 96W, Class 2	1-4

For other power supply options consult factory.

ACCESSORIES - Installation



WMA00_
Adjustable bracket
6 - Antique White
E - White
H - Anthracite

Job Name/Date:

Fixture Type Designation:

PHOTOMETRIC DATA

Note all Photometry is 3000K

T - 10° CRI 80

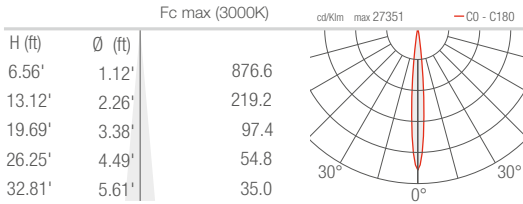

S - 14° CRI 80

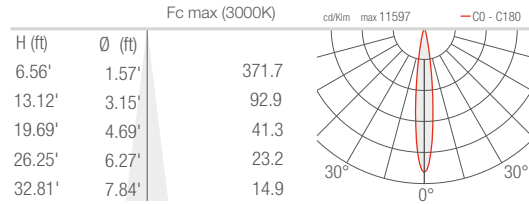

M - 30° CRI 80

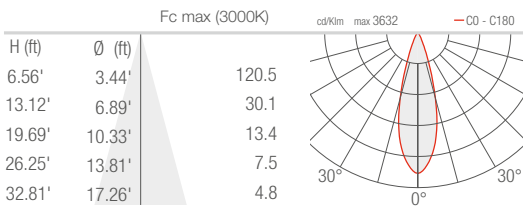

L - 35° CRI 80

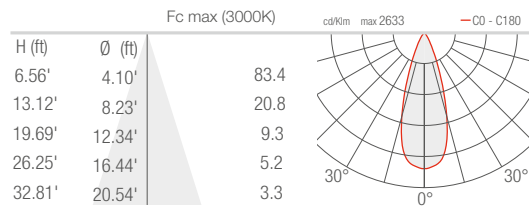

J - 43° CRI 80

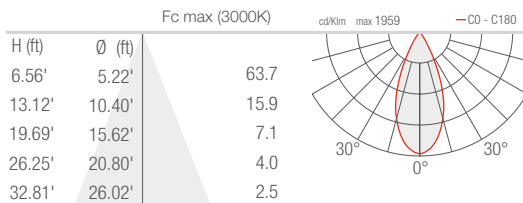

K - 63° CRI 80

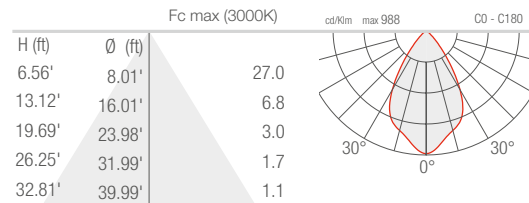

W - 18°x44° CRI 80

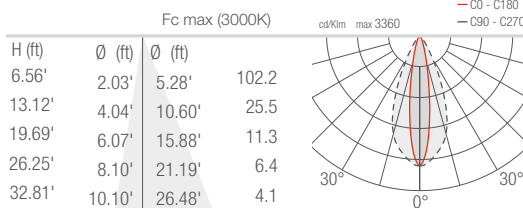

X - 44°x18° CRI 80

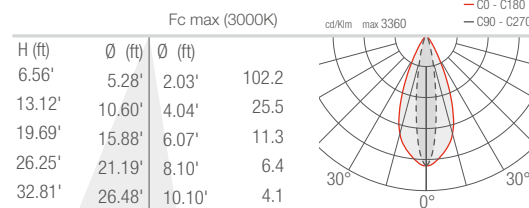

Job Name/Date:

Fixture Type Designation: