

# EYE 80 • EYE 125 • EYE 200

## Surface Version

EYE is a ceiling lamp that comes in a recessed or surface-mounted version with 3 sizes each. It offers high luminous efficiency and perfect luminance control with 3 optics options: spot, flood and wide flood.



Fixture Dimensions - see page 2

### TECHNICAL DATA

<b>Wattage</b>	5W, 12W, 20W
<b>Power Supply</b>	Remote 24VDC - See page 3 (EYE 80) Remote 350mA (EYE 125), 500mA (EYE 200)
<b>Construction</b>	Body: Die-Cast Aluminum Lens: Extra Clear Glass Diffuser
<b>CCT</b>	3000K (2700K, 4000K on request)
<b>BUG Rating</b>	B1-U0-G0 (EYE 80 40° & 60°) B1-U1-G0 (EYE 125 40° & 60°) B2-U1-G0 (EYE 200 40° & 60°)
<b>CRI</b>	>90
<b>Delivered Lumens</b>	400 lm (EYE 80, 40°, 3000K) 950 lm (EYE 125, 40°, 3000K) 1400 lm (EYE 200, 40°, 3000K)
<b>Efficacy</b>	80 lm/W (EYE 80, 40°, 3000K) 63 lm/W (EYE 125, 40°, 3000K) 58 lm/W (EYE 200, 40°, 3000K)
<b>Optics</b>	20°, 40°, 60°
<b>Finishes</b>	5 Standard, See Below
<b>Fixture Dimensions</b>	Ø3.22" x 1.97" (EYE 80) Ø5.12" x 3.03" (EYE 125) Ø8.46" x 4.84" (EYE 200)
<b>Aperature</b>	Ø3.15" (EYE 80) Ø4.92" (EYE 125) Ø7.87" (EYE 200)
<b>Lumen Maintenance</b>	L70 >50,000hrs (Ta 40°C)
<b>Color Consistency</b>	3-Step MacAdam
<b>IP Rating</b>	IP65
<b>Impact Resistance</b>	IK08

### ORDERING INFORMATION

Example: LNEY60POSFHB7ZG.US. Power Supplies / Accessories ordered separately.

LNEY					US
Model #	Size	Optics	Power	Finish	
LNEY	50 POS - EYE 80 (5W) 60 POS - EYE 125 (12W) 80 POS - EYE 200 (20W)	S - 20° Spot F - 40° Flood W - 60° Wide	HB7Z - Remote Driver (EYE 80) HBAZ - Remote Driver (EYE 125) HBDZ - Remote Driver (EYE 200)	L - Graphite V - Oxide U - White G - Black H - Gray	US

Job Name/Date:

Fixture Type Designation:

### FIXTURE DIMENSIONS

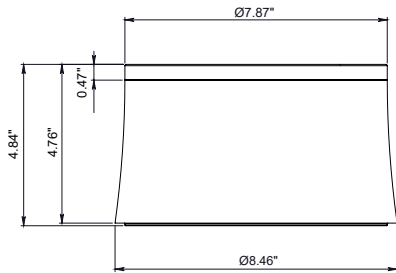

EYE 200

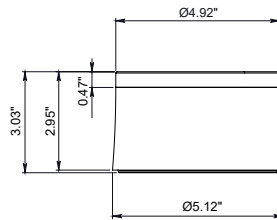
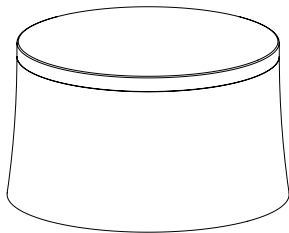

EYE 125

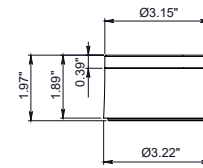
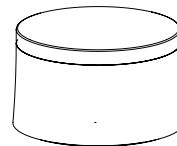

EYE 80

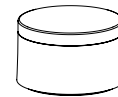

Job Name/Date:

Fixture Type Designation:

## Surface Version

datasheet

### SUGGESTED POWER SUPPLIES

24VDC - EYE 80 (5W)

Part Number	Description	Input/Output	# of Fixtures - 5W
<a href="#">PPLT00149</a>	Non-Dim	120VAC to 24VDC, 10W, Class 2, IP65	1-1
<a href="#">PPLT00632</a>	0-10V Dimming (Dim to Off)	120-277VAC to 24VDC, 12W, Class 2	1-1
<a href="#">PPLT00155</a>	Non-Dim	120VAC to 24VDC, 30W, Class 2	1-4
<a href="#">PPLT00709</a>	ELV / TRIAC & 0-10V Dimming	120-277VAC to 24VDC, 96W, Class 2, DAMP	1-15
<a href="#">PPLT00543</a>	0-10V Dimming to 15% (-40°C / -40°F cold weather start)	120-277VAC to 24VDC, 100W, Class 2	2-16

### Suggested Lutron Compatible - EYE 80 (5W)

Part Number	Option	Lutron SKU	Dim Range	Description	Input/Output	# of Fixtures
<a href="#">PPLT00500</a>	LTEA2W	LTEA	100%-1%	Hi-Lume™ 1% 2-Wire LED Driver (120V forward phase only)	120VAC to 24VDC, 40W, Class 2	1-6
<a href="#">PPLT00273</a>	L3DAE / L3DA3W	L3DA	100%-1%	Hi-Lume™ 1% EcoSystem™ or 1% 3-Wire LED Driver	120-277VAC to 24VDC, 40W, Class 2	1-6

350mA - EYE 125 (12W)

Part Number	Description	Input/Output	# of Fixtures - 12W
<a href="#">PPLT00468</a>	Phase Dim (120V only)	120VAC to 350mA, 14W, Class 2	1-1
<a href="#">PPLT00308-P</a>	0-10V Dimming to 0.1%	120-277VAC to 350mA, 30W, Class 2	1-1
<a href="#">PPLT00263</a>	Leading / Trailing Edge Dimming to 10% (120V only)	120-277VAC to 350mA, 32W, Class 2	1-1
<a href="#">PPLT00538-P</a>	0-10V Dimming to 0.1% (4 channels)	120-277VAC to 350mA, 100W, Class 2	11 (1-4)

### Suggested Lutron Compatible - EYE 125 (12W)

Part Number	Option	Lutron SKU	Dim Range	Description	Input/Output	# of Fixtures
<a href="#">PPLT00271</a>	LTEA2W	LTEA	100%-1%	Hi-Lume™ 1% 2-Wire LED Driver (120V forward phase only)	120VAC to 350mA, 13W, Class 2	1-1
<a href="#">PPLT00516</a>	L3DAE / L3DA3W	L3DA	100%-1%	Hi-Lume™ 1% EcoSystem™ or 1% 3-Wire LED Driver	120-277VAC to 350mA, 13W, Class 2	1-1

500mA - EYE 200 (20W)

Part Number	Description	Input/Output	# of Fixtures - 20W
<a href="#">PPLT00527</a>	Phase Dim (120V only)	120VAC to 500mA, 20W, Class 2, IP66	1-1
<a href="#">PPLT00308-P</a>	0-10V Dimming to 0.1%	120-277VAC to 500mA, 30W, Class 2, DAMP	1-1
<a href="#">PPLT00262</a>	Leading / Trailing Edge Dimming to 10% (120V only)	120-277VAC to 500mA, 32W, Class 2	1-1
<a href="#">PPLT00538-P</a>	0-10V Dimming to 0.1% (4 channels)	120-277VAC to 500mA, 100W, Class 2	1-1 (1-4)

### Suggested Lutron Compatible - EYE 200 (20W)

Part Number	Option	Lutron SKU	Dim Range	Description	Input/Output	# of Fixtures
<a href="#">PPLT00195</a>	L3DAE / L3DA3W	L3DA	100%-1%	Hi-Lume™ 1% EcoSystem™ or 1% 3-Wire LED Driver	120-277VAC to 500mA, 19W, Class 2	1-1

For other power supply options consult factory.

Job Name/Date:

Fixture Type Designation:

### PHOTOMETRIC DATA

Note: All photometric data is 3000K

#### EYE 80

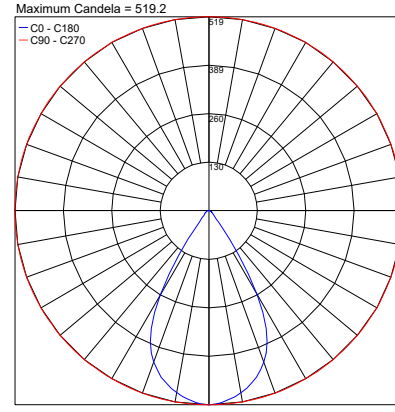
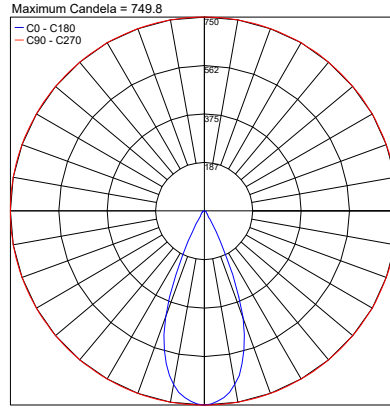
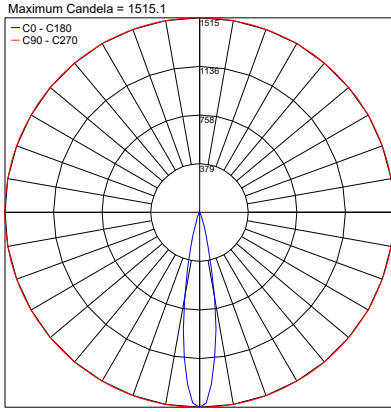

#### EYE 125

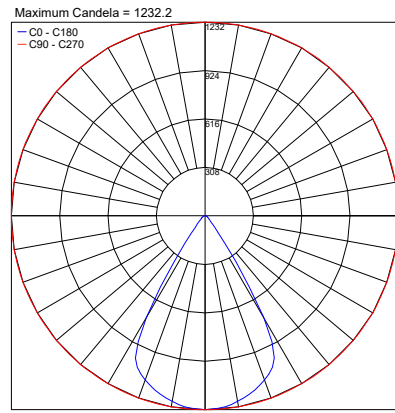
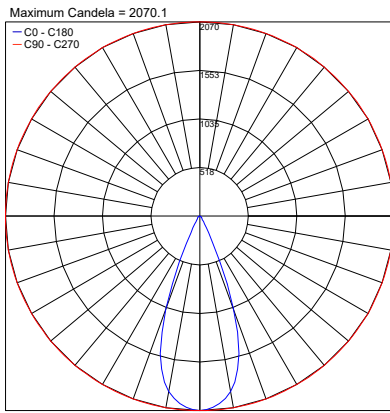
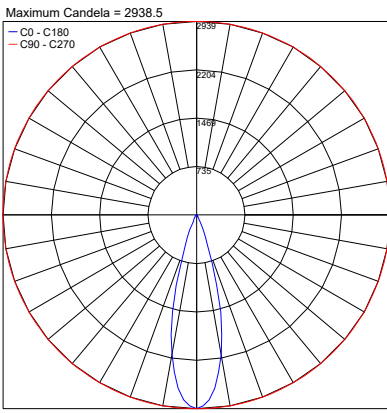

#### EYE 200

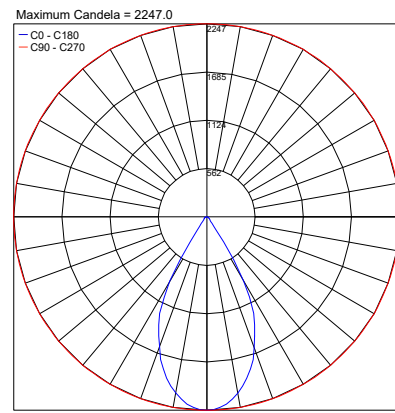
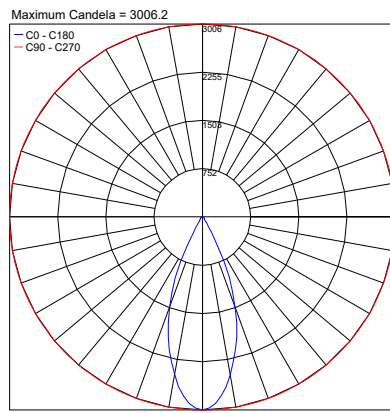
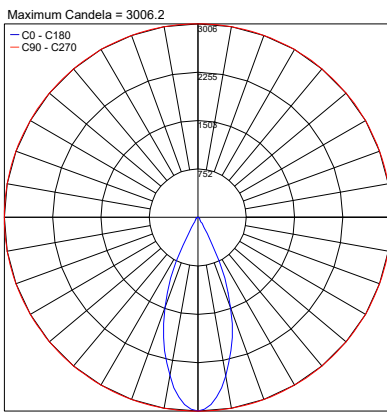

Job Name/Date:

Fixture Type Designation: