

ECLIPSE LINEAR

350 AND 600

Eclipse Linear is an outdoor rectangular wall mounted fixture that creates a diffused light through its perimeter. It is available in a 13.2" or 23.4" version with 360° optics and 3 standard finishes.

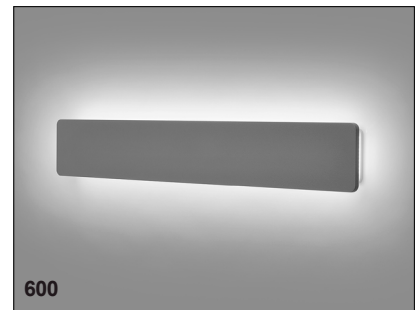
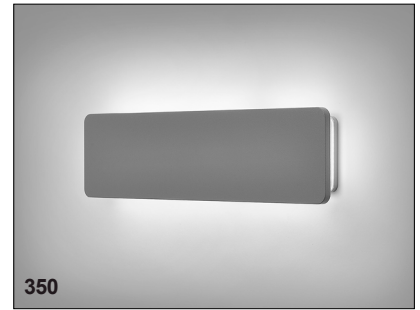

TECHNICAL DATA

Wattage / Input	350: 14W, 600: 24W (120VAC)
Power Supply	Integral
Construction	Body: Die-Cast Copper-Free Aluminum Lens: Frosted Polycarbonate Diffuser
CCT	3000K
BUG Rating	B0-U3-G1
Delivered Lumens	584 lm (350), 781 lm (600)
Efficacy	41.7 lm/W (350), 32.5 lm/W (600)
Optics	360° Diffuse
Finishes	Textured Gray, Anthracite Gray, Matte Black on request
Fixture Dimensions	13.9" l x 1.28" w x 3.66" h (350) 23.4" l x 1.28" w x 3.66 l (600)
Fixture Weight	3.3 lbs (350). 4.4 lbs (600)
LED Source	Low Power CREE LED
IP Rating	IP65
Impact Rating	IK08

Fixture Dimensions

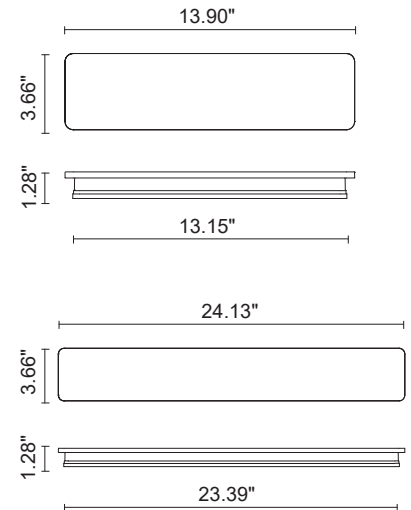

ORDERING INFORMATION

Example: 401710P-30K-360-TG

	- 30K	- 360	-	
Model No.	CCT	Optic	Finish	
401709P (350 - 14W) 401710P (600 - 24W)	30K - 3000K	360 - 360°	TG - Textured Gray AG - Anthracite Gray MB - Matte Black	

Job Name/Date:

Fixture Type Designation:

PHOTOMETRIC DATA

Linear 350

Maximum Candela = 144.3

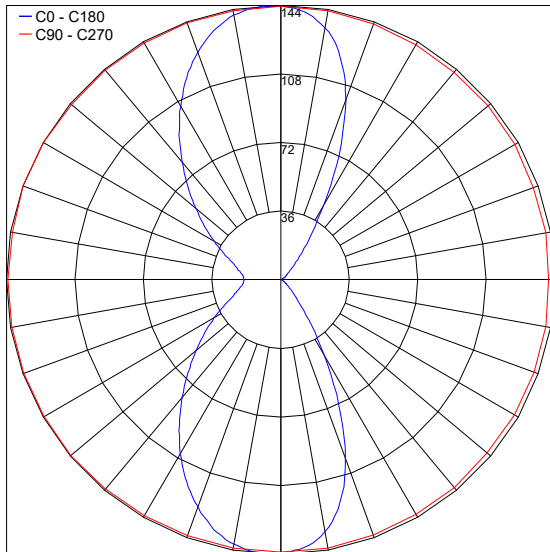

PHOTOMETRIC FILENAME : ECLIPSE LINEAR 350 LED 18W 401709P.IES

Linear 600

Maximum Candela = 189.7

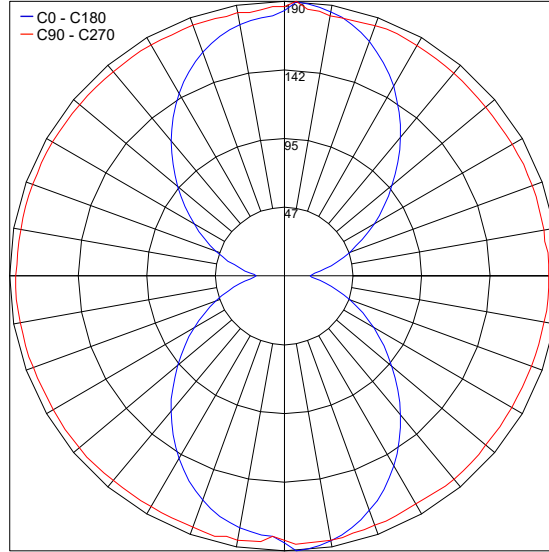

PHOTOMETRIC FILENAME : ECLIPSE LINEAR 600 LED 24W 401710P.IES

Job Name/Date:

Fixture Type Designation:

ECLIPSE LINEAR

350 AND 600

PHOTOMETRIC DATA

Linear 350

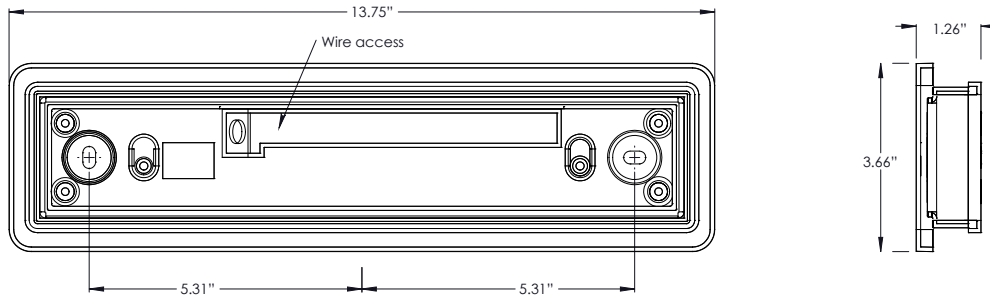

Horizontal Switch Box

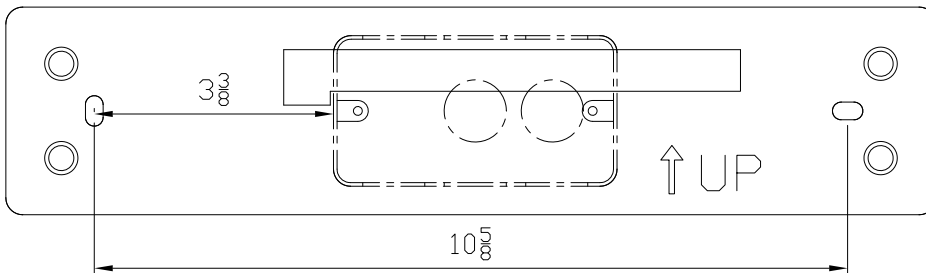

Linear 600

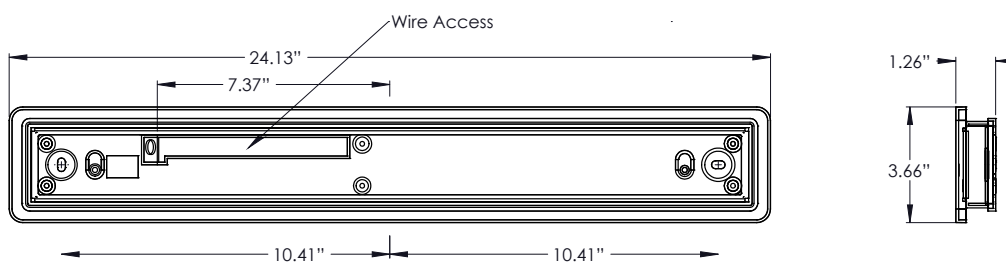

Horizontal Switch Box

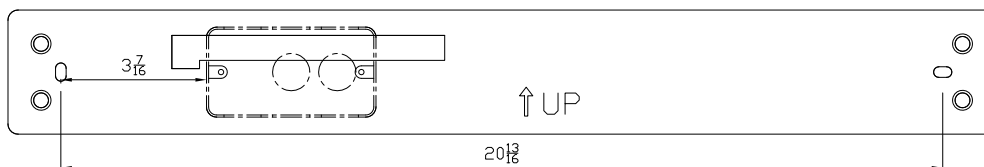

Job Name/Date:

Fixture Type Designation: