

End is an indoor, semi-recessed, continuous line, indirect lighting system made of AirCoral® for installation on walls and ceilings. The overlapping of light source avoids any kind of shadow cone. It is available in 3000K as standard with a 120° light beam.



Fixture Dimensions & Parts  
See page 2

## TECHNICAL DATA

<b>Wattage / Input</b>	28W (24VDC)
<b>Power Supply</b>	Remote, not included. See page 2.
<b>Construction</b>	Body: AirCoral® Lens: Frosted Polycarbonate
<b>CCT</b>	3000K (2700K on request)
<b>CRI</b>	>90
<b>Initial Lumens</b>	2800 lm (3000K)
<b>Efficacy</b>	100 lm/W
<b>Optics</b>	120° Diffused
<b>Finishes</b>	AirCoral® Unfinished Plaster
<b>Fixture Dimensions</b>	46.46" l x 5.71" w x 4.53" h
<b>Cut-out Dimension</b>	46.46" for each module installed
<b>Fixture Weight</b>	13.23 lbs
<b>IP Rating</b>	IP40

The body is made of AirCoral® a unique patented composite material that actually purifies the air. It can be calculated how many cubic feet each fixture will purify. See website for AirCoral® calculator.

Additionally, AirCoral® is:

- Antibacterial.
- Antifungal.
- Scratch-resistant.
- Dust-resistant.
- Suitable for painting.
- LEED recognized material.

## ORDERING INFORMATION

Example: BU8200.AC.30.US + BU8219. Accessories Required / Power Supplies ordered separately.

		<b>US</b>
<b>Model No.</b>	<b>CCT</b>	
BU8200.AC + BU8219 (Ceiling/Wall Body Frame + Light Source)	30 - 3000K (standard) 27 - 2700K (on request)	<b>US</b>

Job Name/Date:

Fixture Type Designation:

## FIXTURE DIMENSIONS

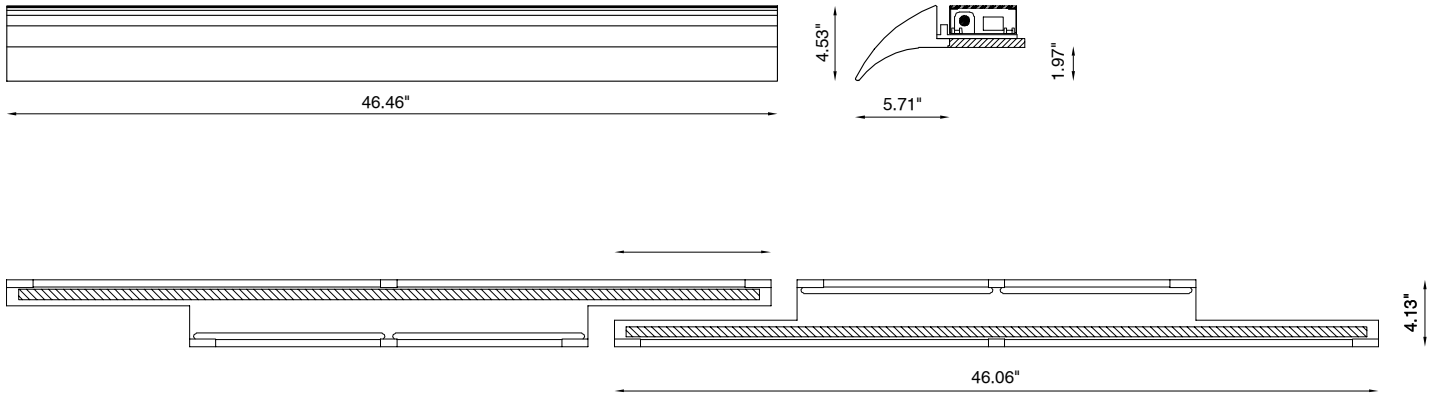

## SUGGESTED POWER SUPPLIES

24VDC

Part Number	Description	Input/Output	# of Fixtures
<a href="#">PPLT00090</a>	Non-Dim	120VAC to 24VDC, 75W, Class 2	1-2
<a href="#">PPLT00709</a>	ELV / TRIAC & 0-10V Dimming	120-277VAC to 24VDC, 96W, Class 2, DAMP	1-2
<a href="#">PPLT00158</a>	Non-Dim	120VAC to 24VDC, 100W, Class 2	1-2
<a href="#">PPLT00543</a>	0-10V Dimming to 15% (-40°C / 40°F cold weather start)	120-277VAC to 24VDC, 100W, Class 2	1-2

For other power supply options consult factory.

### ATTENTION

*BU8219 (28W LED) and BU8200.AC must be ordered together.*

#### Optional Accessory:

*BU8210 - Protection Shield (ordered separately - see page 3)*

Job Name/Date:

Fixture Type Designation:

## EXAMPLE OF INSTALLATION

Optional - Protection Shield  
Code BU8210

Code BU8219 (28W)

Code BU8200.AC

**ATTENTION**  
*BU8219 (28W LED) and  
BU8200.AC must be ordered together.*

**Optional Accessory:**  
*BU8210 - Protection Shield  
(ordered separately)*

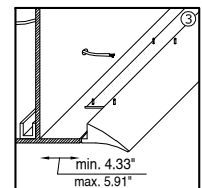
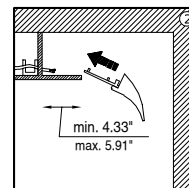
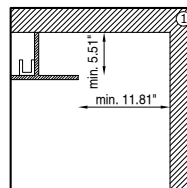
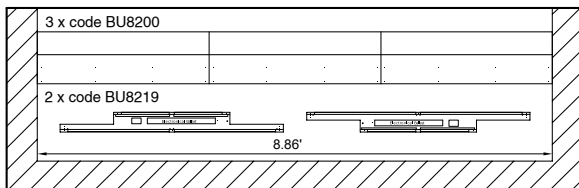
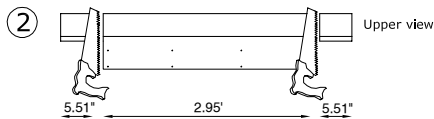
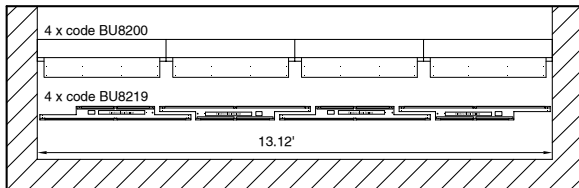
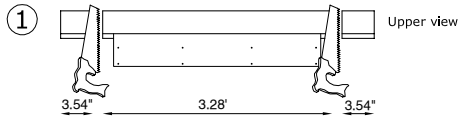

Job Name/Date:

Fixture Type Designation: