

The FA100-WD is a modern, outdoor, wall mounted LED luminaire with downward light emission, that is energy efficient and offers different light distributions for use in street, path, and area lighting.

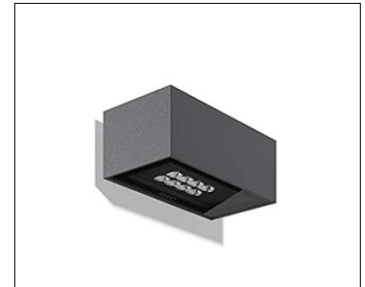

FA100-WD (8 LED)



FA100-WD (16 LED)

## TECHNICAL DATA

<b>Wattage / Input</b>	4.8W - 12.3W
<b>Power Supply</b>	Integral (120-277VAC)
<b>Construction</b>	Body: EN44300 Die-Cast Aluminium Cover: Single-Pane Safety Glass (ESG) 0.24" thick
<b>CCT</b>	2200K, 2700K, 3000K, 4000K
<b>CRI</b>	3000K >80 2200K, 2700K, 4000K, >70
<b>Delivered Lumens</b>	361-782 lm (8 LED, 3000K, AS09 Satiné RBL) 722-1564 lm (16 LED, 3000K, AS09 Satiné RBL)
<b>Efficacy</b>	74.7-63.8 lm/W (3000K, AS09 Satiné RBL)
<b>Optics</b>	3 Downward Distributions, see below Reduction of the back light through adequate shielding (RBL).
<b>Finishes</b>	Silver-Gray Polyester Powder Coating (RAL 9007 / DB 702)
<b>Fixture Dimensions</b>	4.88" w x 7.87" l x 3.15" h
<b>Fixture Weight</b>	9.92 lbs
<b>IP Rating</b>	IP66
<b>Impact Rating</b>	IK09 (IK10 on request)
<b>Lateral Windage Area</b>	0.215 ft <sup>2</sup>
<b>Upper Windage Area</b>	0.215 ft <sup>2</sup>

## Fixture Dimensions

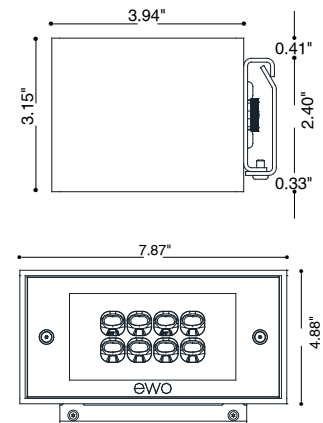

## ORDERING INFORMATION

Example: FA100-WD-08-30-AS09S-RBL-S.

FA100-WD	-		-		-		-		-	
<b>Model No.</b>	<b>LED</b>	<b>CCT</b>	<b>Optics</b>	<b>Backlight Shield</b>	<b>Finish</b>					
FA100-WD	08 - 8 LED 16 - 16 LED	22 - 2200K 27 - 2700K 30 - 3000K 40 - 4000K	AP07S - AP07 Satiné AS08S - AS08 Satiné AS09S - AS09 Satiné	RBL - Reduced Backlight 000 - No Backlight Shield	S - Silver-gray C - Custom (consult factory)					

Job Name/Date:

Fixture Type Designation:

## FIXTURE DIMENSIONS

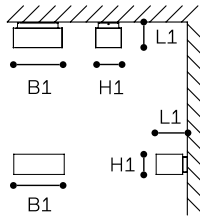

MODEL #	L1 (in)	H1 (in)	B1 (in)
FA100-WD	4.9"	3.2"	7.9"
FA100-WU	4.9"	3.2"	7.9"
FA100-C	4.0"	4.1"	7.9"

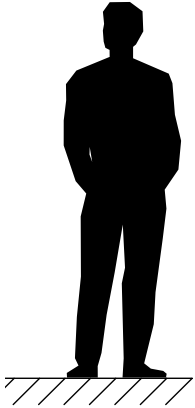

## LIGHT DISTRIBUTIONS

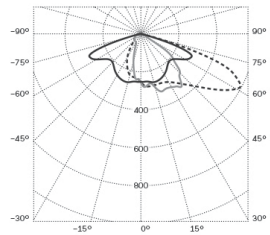

AS07  
Asymmetric Side Throw

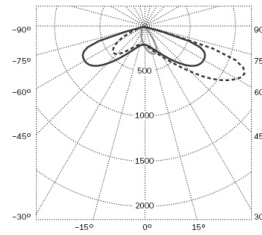
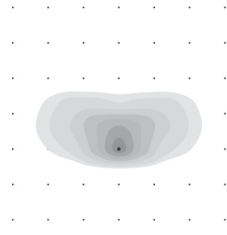

AS09  
Asymmetric Extra Side Throw

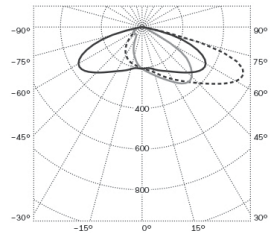
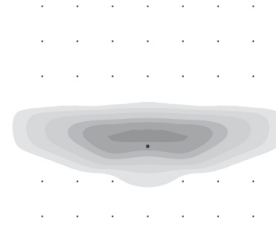

AS08  
Asymmetric Side and Forward Throw

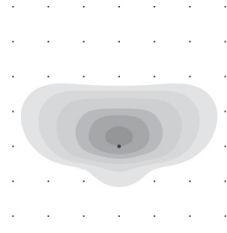

Job Name/Date:

Fixture Type Designation: