

FOG 80 • FOG 125 • FOG 200

Recessed Wall

FOG is an outdoor ceiling or wall fixture that comes in a recessed or surface-mounted versions with 3 diameter sizes each offering resistance and longevity. The FOG recessed ceiling version can be installed recessed, flush or protruding and diffused light beam.



TECHNICAL DATA

Wattage	6W, 14.5W, 22W
Power Supply	Remote 24VDC (FOG 80) - See page 3 Remote 700mA (FOG 125), 1050mA (FOG 200)
Construction	Body: Die-Cast Aluminum Lens: Opal Glass
CCT	3000K (other colors on request)
BUG Rating	B0-U1-G0 (Fog 80) B1-U1-G1 (Fog 125, Fog 200)
CRI	>90
Delivered Lumens	345 lm (FOG 80) 950 lm (FOG 125) 1500 lm (FOG 200)
Efficacy	58 lm/W (FOG 80) 54 lm/W (FOG 125) 56 lm/W (FOG 200)
Optics	Diffuse
Finishes	White
Fixture Dimensions	Ø3.15" x 4.72" (FOG 80) Ø4.92" x 4.76" (FOG 125) Ø7.87" x 4.72" (FOG 200)
Lumen Maintenance	L70 >50,000hrs (Ta 40°C)
Color Consistency	3-Step MacAdam
IP Rating	IP65
Impact Resistance	IK08

Fixture Dimensions & Installation Options - see page 2

ORDERING INFORMATION

Example: LNFG60ISODHB7ZU.US. Power Supplies / Accessories ordered separately.

LNFG		D		U	US
Model No.	Size	Optics	Power	Finish	
LNFG	50 ISO - FOG 80 60 ISO - FOG 125 80 ISO - FOG 200	D - Diffuse	HB7Z - Remote Driver (FOG 80) HB10 - Remote Driver (FOG 125/200)	U - White	US

Job Name/Date:

Fixture Type Designation:

FIXTURE DIMENSIONS

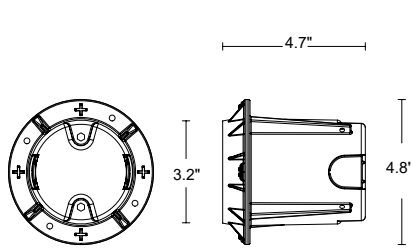

FOG 80

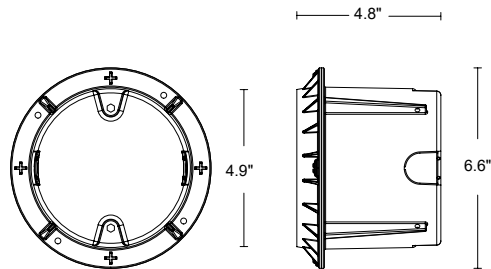

FOG 125

HOUSING BOX - Included

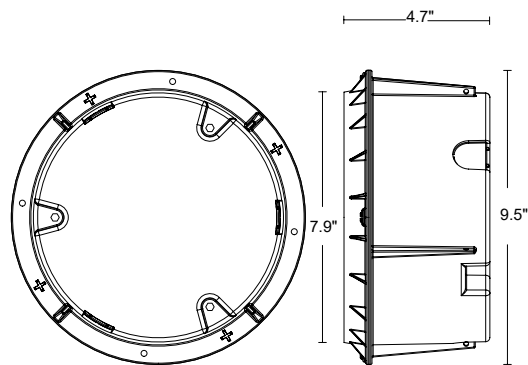
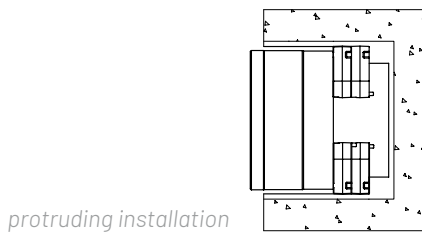
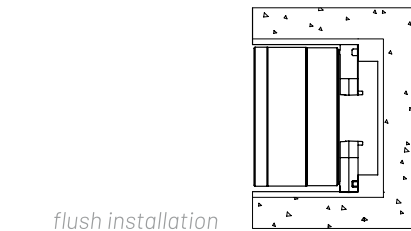
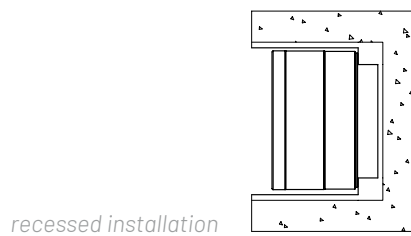

FOG 200

Job Name/Date:

Fixture Type Designation:

SUGGESTED POWER SUPPLIES

24VDC - FOG 80 (6W)

Part Number	Description	Input/Output	# of Fixtures
PPLT00149	Non-Dim	120VAC to 24VDC, 10W, Class 2, IP65	1-1
PPLT00632	0-10V Dimming (Dim to Off)	120-277VAC to 24VDC, 12W, Class 2	1-1
PPLT00155	Non-Dim	120VAC to 24VDC, 30W, Class 2	1-4
PPLT00158	Non-Dim	120VAC to 24VDC, 100W, Class 2	1-13
PPLT00543	0-10V Dimming to 15% (-40°C / -40°F cold weather start)	120-277VAC to 24VDC, 100W, Class 2	2-13

Suggested Lutron Compatible - FOG 80 (6W)

Part Number	Option	Lutron SKU	Dim Range	Description	Input/Output	# of Fixtures
PPLT00273	L3DAE / L3DA3W	L3DA	100%-1%	Hi-Lume™ 1% EcoSystem™ or 1% 3-Wire LED Driver	120-277VAC to 24VDC, 40W, Class 2	1-5

700mA - FOG 125 (14.5W)

Part Number	Description	Input/Output	# of Fixtures
PPLT00465-P	0-10V Dimming to 1.0%	120-277VAC to 700mA, 20W, Class 2, DAMP	1-1
PPLT00308-P	0-10V Dimming to 0.1%	120-277VAC to 700mA, 30W, Class 2, DAMP	1-2
PPLT00538-P	0-10V Dimming to 0.1% (4 channels)	120-277VAC to 700mA, 100W, Class 2	1-1 (1-4)

Suggested Lutron Compatible - FOG 125 (14.5W)

Part Number	Option	Lutron SKU	Dim Range	Description	Input/Output	# of Fixtures
PPLT00517	L3DAE / L3DA3W	L3DA	100%-1%	Hi-Lume™ 1% EcoSystem™ or 1% 3-Wire LED Driver	120-277VAC to 700mA, 27W, Class 2	1-1
PPLT00181	L3DAE / L3DA3W	L3DA	100%-1%	Hi-Lume™ 1% EcoSystem™ or 1% 3-Wire LED Driver	120-277VAC to 700mA, 38W, Class 2	2-2

1050mA - FOG 200 (22W)

Part Number	Description	Input/Output	# of Fixtures
PPLT00308-P	0-10V Dimming to 0.1%	120-277VAC to 1050mA, 30W, Class 2, DAMP	1-1
PPLT00467-P	0-10V Dimming to 1.0%	120-277VAC to 1050mA, 50W, Class 2, DAMP	1-2
PPLT00538-P	0-10V Dimming to 0.1% (4 channels)	120-277VAC to 1050mA, 100W, Class 2	1-1 (1-4)

Suggested Lutron Compatible - FOG 200 (22W)

Part Number	Option	Lutron SKU	Dim Range	Description	Input/Output	# of Fixtures
PPLT00621	L3DAE / L3DA3W	L3DA	100%-1%	Hi-Lume™ 1% EcoSystem™ or 1% 3-Wire LED Driver	120-277VAC to 1050mA, 40W, Class 2	1-1

For other power supply options consult factory.

Job Name/Date:

Fixture Type Designation:

ACCESSORIES - Optional

00KEY50 - FOG 80
00KEY60 - FOG 125
00KEY80 - FOG 200
Leveling Kit

010829600000 - FOG 80
010829700000 - FOG 125
010829800000 - FOG 200
Plastering Rim

0303003 - FOG 80
0303004 - FOG 125, FOG 200
*Suction Cup
to screw the glass*

PHOTOMETRIC DATA

Note: All photometric data is 3000K

FOG 80

Maximum Candela = 96

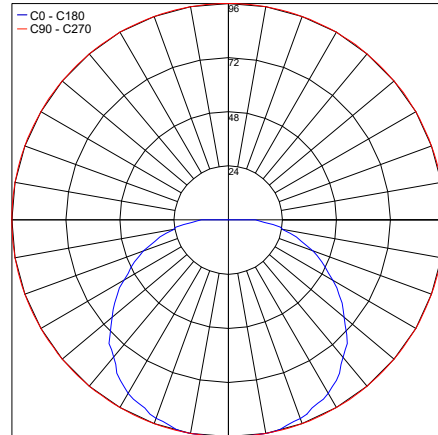

FOG 125

Maximum Candela = 275.7

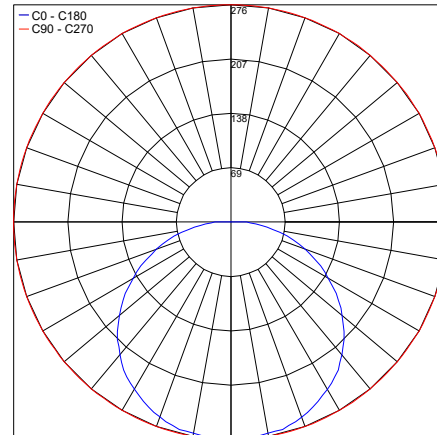

FOG 200

Maximum Candela = 452.4

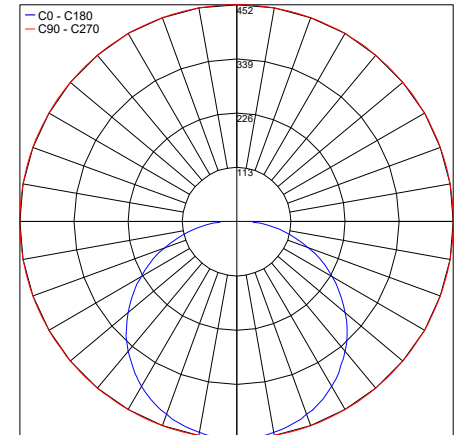

Job Name/Date:

Fixture Type Designation: