



**INSTRUCTIONS PERTAINING TO RISK OF FIRE OR INJURY TO PERSONS. READ ALL INSTRUCTIONS. IMPORTANT SAFETY INSTRUCTIONS. SAVE THESE INSTRUCTIONS.**

**DANGER - RISK OF SHOCK - DISCONNECT POWER BEFORE INSTALLATION! Please read all instructions before installation.**

- Keep these instructions for future reference.
- Must be installed by a qualified electrician in accordance with national and local standards. Designplan is not responsible for fixtures installed without regard to these standards.
- Unauthorized alterations or tampering of product voids warranty.
- The main power connection must be in accordance with local electrical codes.
- Suitable for INDOOR applications.
- DO NOT INSTALL INSULATION WITHIN 3.0" (76 mm) OF ANY PART OF THE LUMINAIRE.



### Electrical Connections:

- LED lights must be **connected in parallel** respecting polarities.
- **CHOOSE POWER SUPPLY ACCORDINGLY.** Please consider the voltage through which fixtures are fed as well as the max power consumption.
- **Connect power only if all the fixtures are connected.**
- The power supplies **MUST** be installed in aerated rooms, far from heat sources. Overloading or lack of air circulation will not permit natural dissipation.
- For supply connection, use only an isolating low voltage power supply with ungrounded output, evaluated for swimming pool use.
- Never use switches on secondary circuit.

**ATTENTION:** For Wall/Ceiling - It is the contractor's responsibility to caulk around all the edges between the fixture and the mounting surface to satisfy wet label requirements. Contractor **MUST** use gel-filled wire nuts.

### Maintenance

Scheduled maintenance must be carried out once a year on all lighting devices, regardless of appliance class and type of use. It must include the following operations:

- Periodically clean fixtures to remove dirt from gratings and screw heads.
- Check tightness of screws on various parts of the device.
- Check that all cable glands and cables are intact and tight. Check that the glass or plastic lens is intact, and replace it if broken or damaged.
- The internal components such as the ballast, driver, washers and screws must not show clear signs of oxidation or rust. Clear traces of rust and oxidation will indicate the presence of water inside the device.
- In the case of damage, the components must be replaced by original components or spare parts.

1. Operating temperature shall be -25°C to 60°C.

2. Please make sure that even during installation, the predetermined bending direction is NEVER changed. The product can only have top bending, and cannot be twisted. Make sure to follow bending direction at all times and during installation

3. HYDROFLEX MINI LED shall not be bent sharply. PC core and encapsulation cannot prevent any damage.

4. Bending to a tighter radius than 5.9", over bending will damage product and void any warranty. Do not bend beyond minimum bending radius

5. During the installation, the HYDROFLEX MINI LED can not be:

- Twisted
- Dropped
- Bent at a 90° angle or bent at all -
- Sagging/Hanging down

6. Do not leave it together with card or paper directly as it will affect the surface clean.

7. For installation, 3 ways for your selection.

- Mounting clips -
- Alumium profile
- 3M tape

8. For the cutting unit, it is 1.97" for white color and 3.28" for RGB

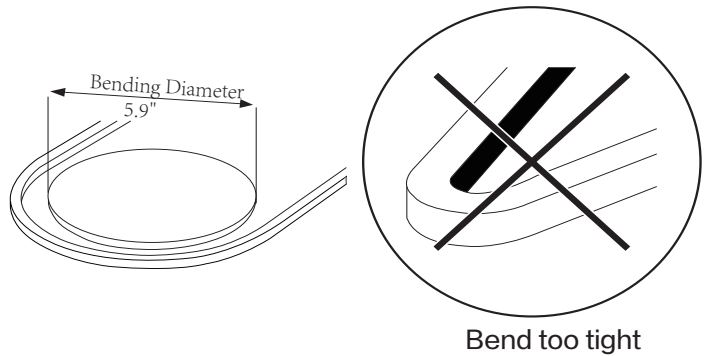
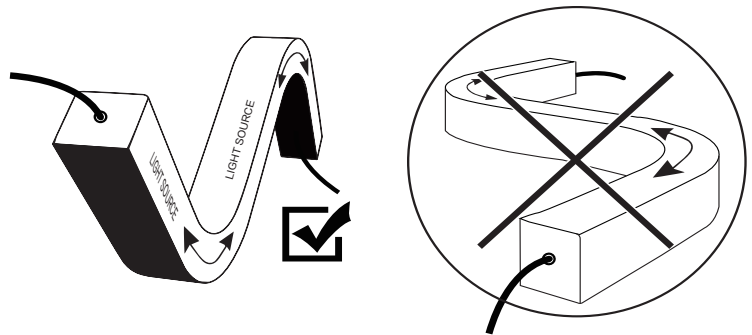
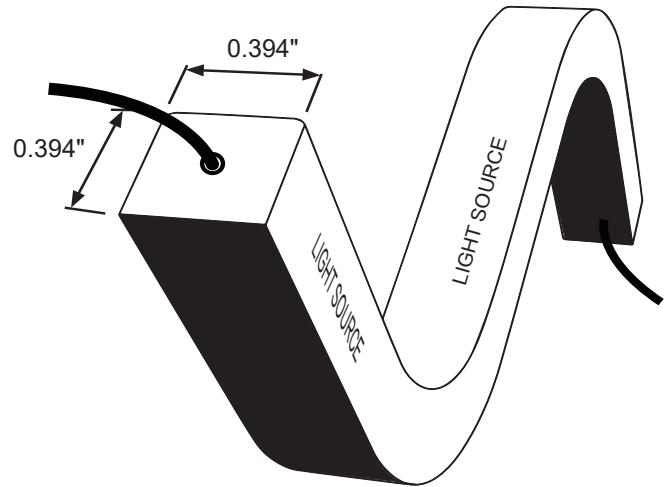

## STANDARD DIMENSION

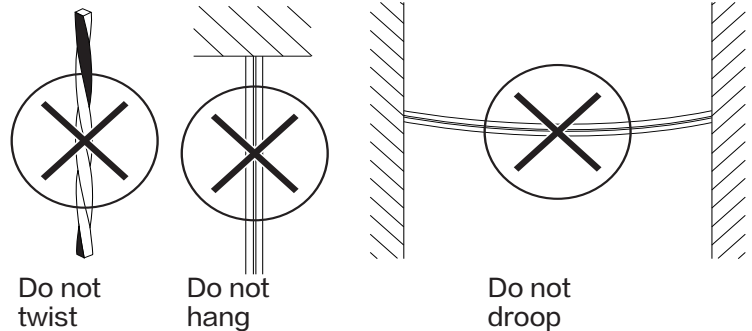
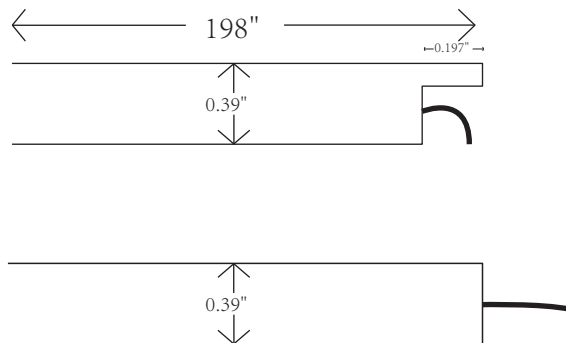

# HYDROFLEX MINI

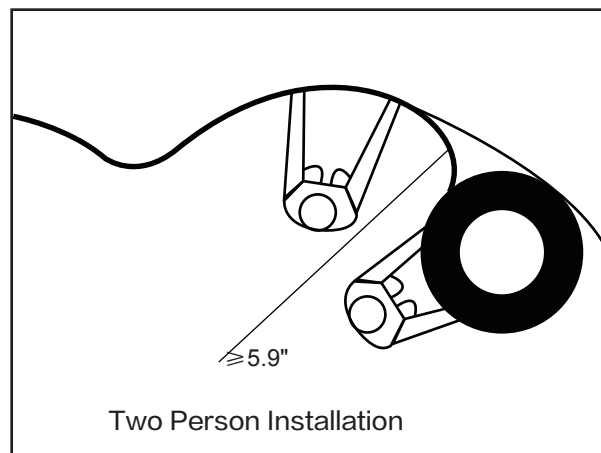
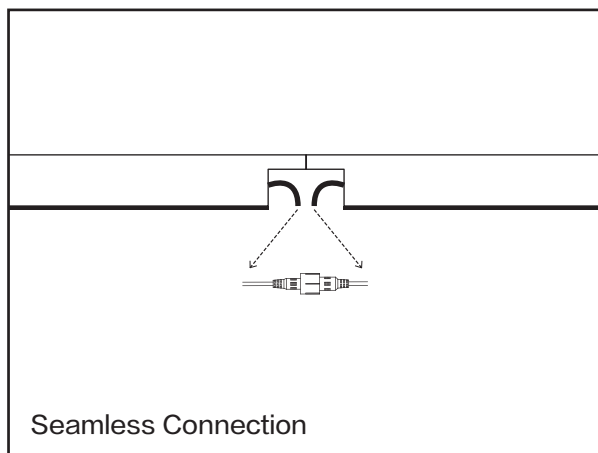
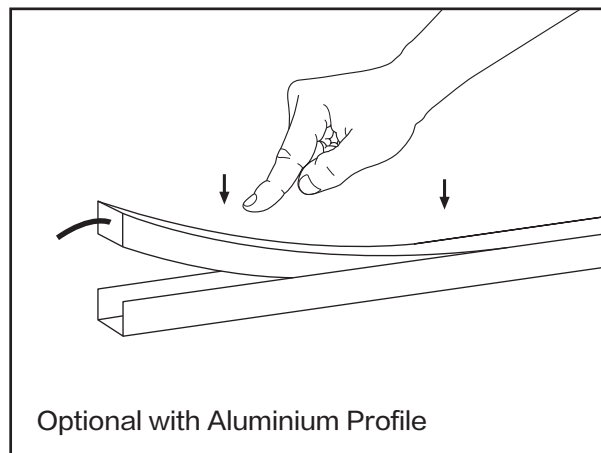
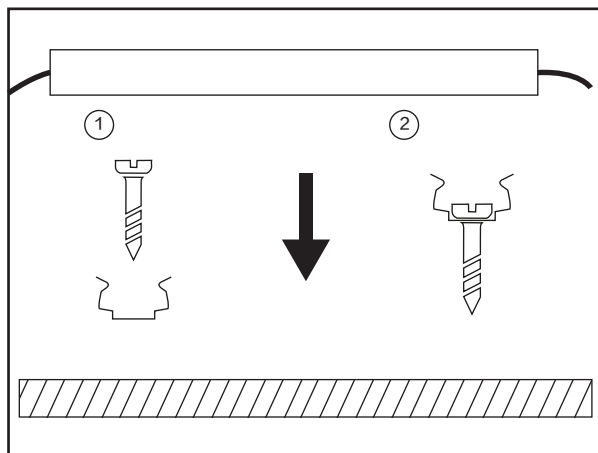
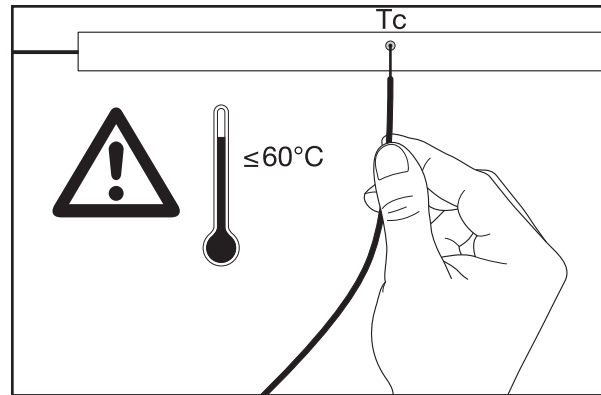
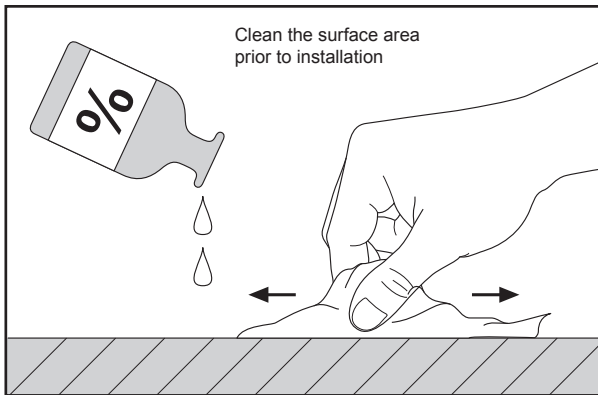
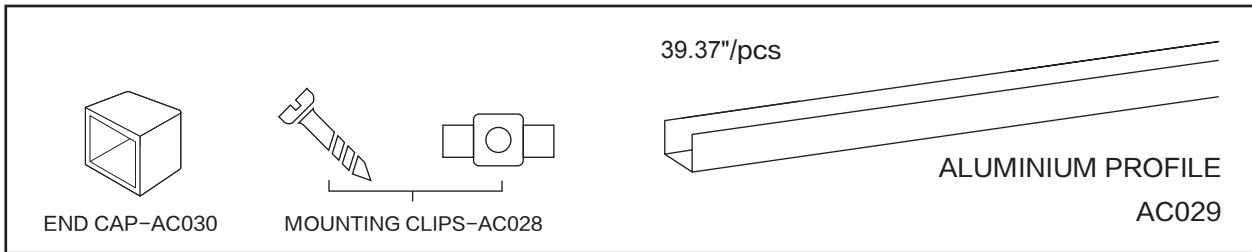

## Wiring Diagram

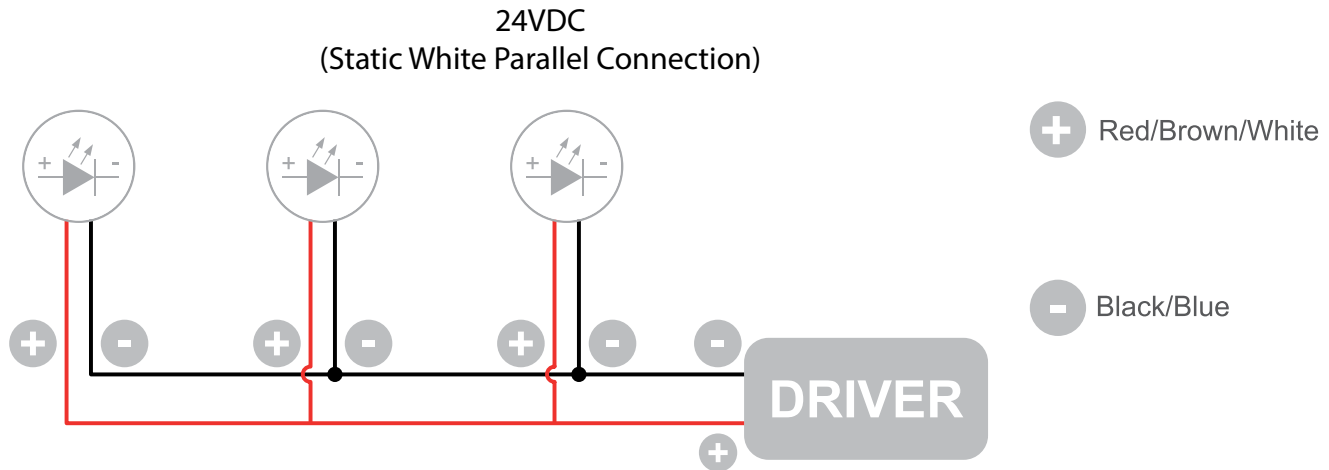

The individual lamps must be connected in parallel. Only power up the system once all the lamps have being connected.

- Only power up the system once all the lamps are connected. Connecting an individual lamp to an active power supply may cause the lamp to break due to over-voltage.
- Lamps and power supply units must be installed in well ventilated boxes or locations to allow a natural heat diffusion and avoid the devices overheating.
- On the power system, install a surge protection device to reduce the intensity of any voltage spikes, to protect the lighting fixtures from the risk of damage.
- Fixture NOT suitable for covering with thermally insulating material.