

INTONO 2.2

Intono is a new family of surface-mounted fixtures with a simple, elegant design which features three innovative characteristics: the **ability to blend in** with the wall it is mounted on, **to play music** and to **communicate with smart-speakers (3.9 and 4.9)** such as Google Home or Amazon Echo, over Wi-Fi using the ZigBee protocol.



TECHNICAL DATA

Wattage / Input	12W (24VDC)
Power Supply	Remote, not included. See page 2.
Construction	Body: Die-Cast Aluminum Fixing Bracket: Stainless Steel AISI 316L Lens: Black-Serigraphed, Tempered, Transparent Extra-Clear Glass
CCT	2700K, 3000K, 4000K
CRI	80, >90
BUG Rating	B0-U2-G0 (3000K, 8°+ 68°) B0-U3-G0 (3000K, 11°+ 68°, 68°+ 68°, Diffuse) B1-U3-G0 (3000K, 11°+ 11°, 34°+ 34°)
Delivered Lumens	704 lm (3000K, 34°, CRI 80) 652 lm (3000K, 34°, CRI >90)
Efficacy	58.7 lm/W (3000K, 34°, CRI 80) 54.3 lm/W (3000K, 34°, CRI >90)
Optics	6 Standard, see below
Finishes	5 Standard, see below
Fixture Dimensions	1.97" w x 2.99" l x 5.91" h
Fixture Weight	1.39 lbs
LED Source	2 Power LEDs
Lumen Maintenance	L90, B10 >50,000hrs (Ta 25°C)
Color Consistency	3-Step MacAdam
Operating Temp.	-4°F to +113°F
IP Rating	IP65
IK Rating	IK04

Fixture Dimensions

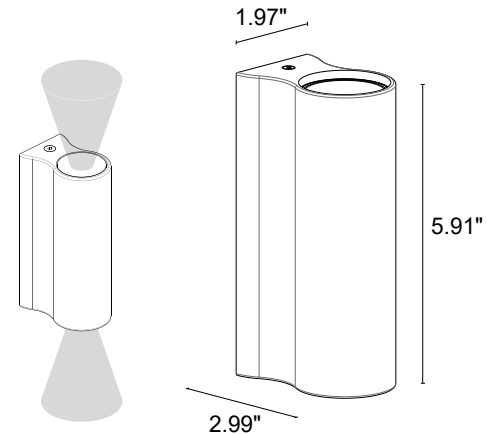

ORDERING INFORMATION

Example: NT221010009ZKE. Power Supplies ordered separately.

NT2210					
Model No.	CRI	Honeycomb Louvre	CCT	Optics	Finish
NT2210	0 - CRI 80 1 - CRI>90	000 - None 001 - Honeycomb Louvre <i>Honeycomb Louvre NOT available with asymmetrical 8° + 68° (ZK) and diffuse + diffuse (DD) optics.</i>	F - 2700K 5 - 3000K 9 - 4000K	TT - 11°+ 11° TK - 11°+ 68° MM - 34°+ 34° KK - 68°+ 68° DD - Diffuse + Diffuse ZK - asymmetrical 8°+ 68°	E - White F - Gray H - Anthracite T - Cor-ten 7 - Primer

Job Name/Date:

Fixture Type Designation:

SUGGESTED POWER SUPPLIES

24VDC

Part Number	Description	Input/Output	# of Fixtures
PPLT00481	Non-Dim	120-277VAC to 24VDC, 24W, Class 2	1-1
PPLT00155	Non-Dim	120VAC to 24VDC, 30W, Class 2	1-2
PPLT00586	Non-Dim	120-277VAC to 24VDC, 40W, Class 2	1-2
PPLT00284	Non-Dim	120-277VAC to 24VDC, 100W, Class 2	1-6
PPLT00543	0-10V Dimming to 15% (-40°C / -40°F cold weather start)	120-277VAC to 24VDC, 100W, Class 2	1-6

Suggested Lutron Compatible

Part Number	Option	Lutron SKU	Dim Range	Description	Input/Output	# of Fixtures
PPLT00273	L3DAE / L3DA3W	L3DA	100%-1%	Hi-Lume™ 1% EcoSystem™ or 1% 3-Wire LED Driver	120-277VAC to 24VDC, 40W, Class 2	1-2
PPLT00530	L3DAE / L3D0	L3DA/L3D0	100%-1%	Hi-Lume™ 0.1% EcoSystem™ or 3-Wire LED Driver	120-277VAC to 24VDC, 96W, Class 2	1-6

For other power supply options consult factory.

ACCESSORIES

Anti-glare

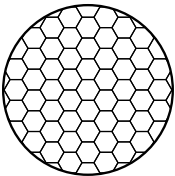

Honeycomb Louvre*

*Optical accessory added in ordering matrix

The honeycomb louvre can be provided on all optics, **EXCEPT** for asymmetrical 8° + 68° (ZK) and diffuse + diffuse (DD) for Intono 2.2.

Job Name/Date:

Fixture Type Designation:

PHOTOMETRIC DATA

Note all Photometry is 3000K

Z – Asymmetrical 8° CRI 80

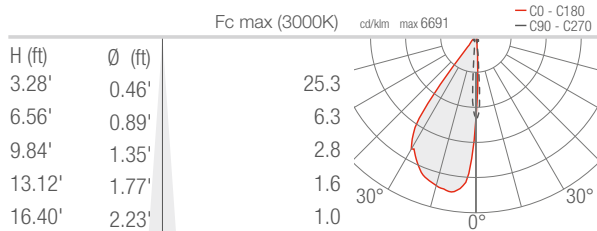

T – 11° CRI 80

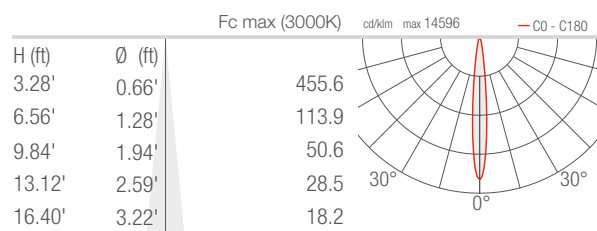

M - 34° CRI 80

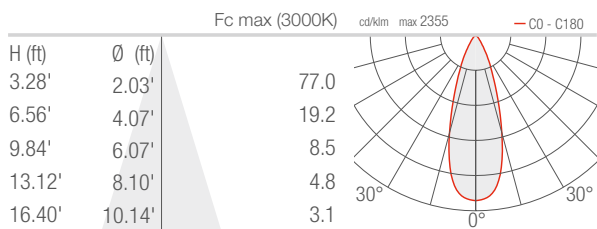

K - 68° CRI 80

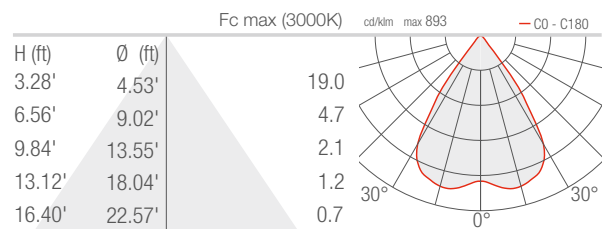

D - Diffuse CRI 80

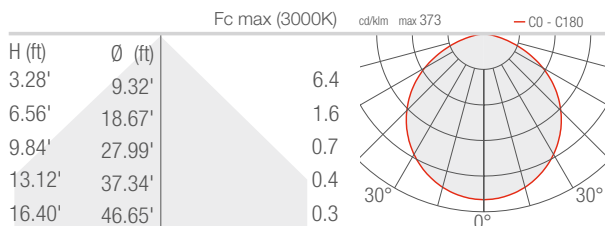

Job Name/Date:

Fixture Type Designation: