

INTONO 3.1

Intono is a new family of surface-mounted fixtures with a simple, elegant design which features three innovative characteristics: the **ability to blend in** with the wall it is mounted on, **to play music** and to **communicate with smart-speakers (3.9 and 4.9)** such as Google Home or Amazon Echo, over Wi-Fi using the ZigBee protocol.



TECHNICAL DATA

Wattage / Input	10W (120VAC)
Power Supply	Integral (0-10V Dimming)
Construction	Body: Die-Cast Aluminum Fixing Bracket: Stainless Steel AISI 316L Lens: Black-Serigraphed, Tempered, Transparent Extra-Clear Glass
CCT	2700K, 3000K, 4000K
CRI	80, >90
BUG Rating	B0-U0-G0 (3000K, Sharp 17°) B0-U1-G0 (3000K, Wall Grazing) B1-U1-G0 (3000K, 15°, 20°, 43°, Asymmetrical)
Delivered Lumens	837 lm (3000K, 15°, CRI 80) 696 lm (3000K, 15°, CRI 90)
Efficacy	83.7 lm/W (3000K, 15°, CRI 80) 69.6 lm/W (3000K, 15°, CRI 90)
Optics	6 Standard, see below
Finishes	5 Standard, see below
Fixture Dimensions	3.15" w x 4.76" l x 9.45" h
Fixture Weight	4.85 lbs
LED Source	1 COB High Density LED
Lumen Maintenance	L95, B10 >50,000hrs (Ta 25°C)
Color Consistency	2-Step MacAdam
Operating Temp.	-4°F to +113°F
IP Rating	IP65
Impact Resistance	IK04

Fixture Dimensions

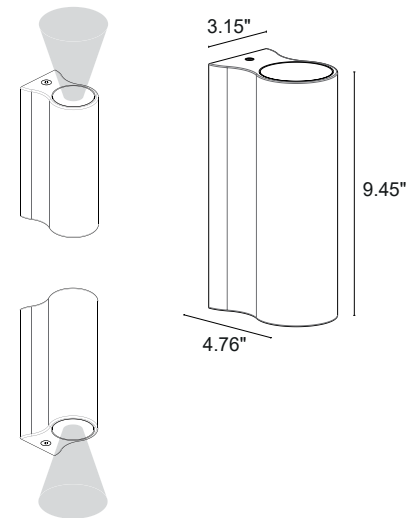

Note: 3.1, 3.2, 3.9, 4.1, 4.2 and 4.9 models to be mounted to the wall over a single gang switch box.

ORDERING INFORMATION

Example: NT31100R01FOZT.

NT3110						
Model No.	CRI	Control	Honeycomb Louvre	CCT	Optics	Finish
NT3110	0 - CRI 80 1 - CRI>90	0 - on/off R - 0-10V	00 - None 01 - Honeycomb Louvre <i>Honeycomb Louvre NOT available with sharp 17° (Z), wall grazing (W) and asymmetrical (A) optics.</i>	F - 2700K 5 - 3000K 9 - 4000K	0Z - Sharp 17° 0S - 15° 0M - 20° 0L - 43° 0W - Wall Grazing 0A - Asymmetrical	E - White F - Gray H - Anthracite T - Cor-ten 7 - Primer

Job Name/Date:

Fixture Type Designation:

ACCESSORIES

Anti-glare

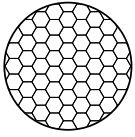

Honeycomb Louvre*

*Optical accessory added in ordering matrix

The honeycomb louvre can be provided on all optics, **EXCEPT** for sharp 17° (Z), wall grazing (W) and asymmetrical (A) optics for Intono 3.1.

PHOTOMETRIC DATA

Note all Photometry is 3000K

Z - Asymmetrical 11° CRI 80

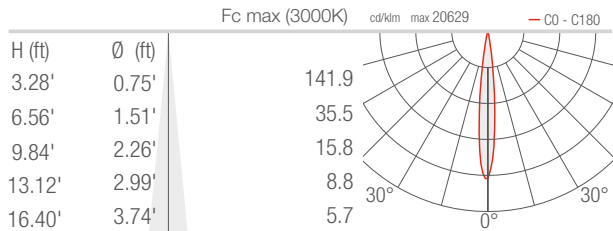

S - 15° CRI 80

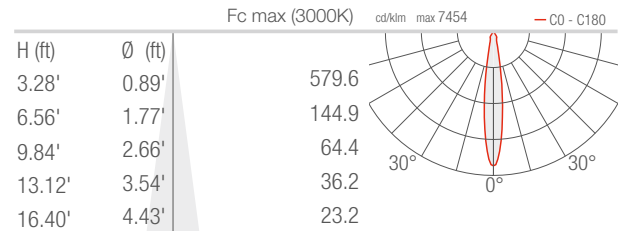

M - 20° CRI 80

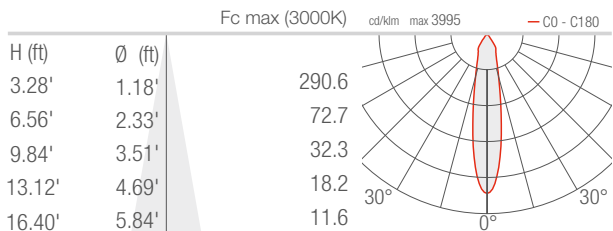

L - 43° CRI 80

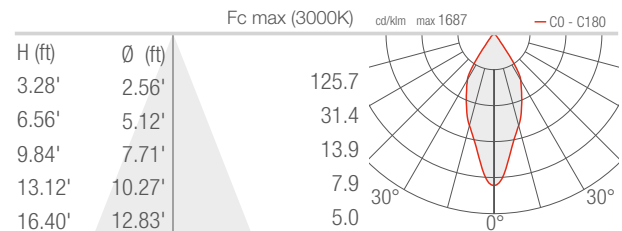

W - Wall grazing CRI 80

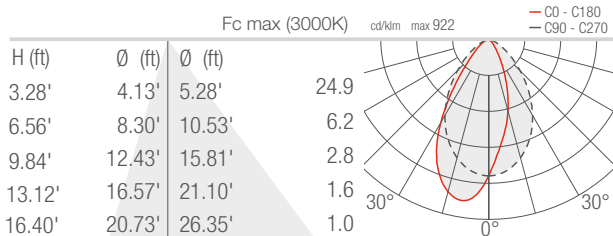

A - Asymmetrical CRI 80

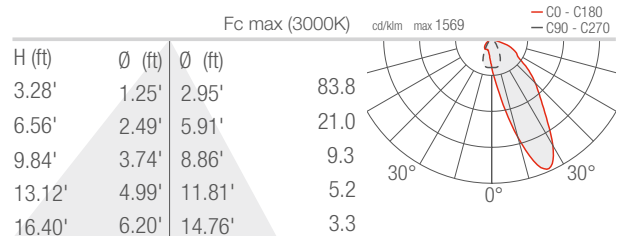

Job Name/Date:

Fixture Type Designation: