

# LITUS 1.0

The Litus 1 series features a sophisticated flush/trimless mount design and with 6 standard optic options are highly versatile for both general and more dynamic lighting. The square version can be used for downlight applications as well. **The Bright 1, Smoothy 1 and Litus 1 series all use the same LED.**



## TECHNICAL DATA

<b>Wattage / Input</b>	2W (700mA)
<b>Power Supply</b>	Remote, not included. See page 2.
<b>Construction</b>	Body: Aluminum alloy EN AW 6082 Lens: Tempered, serigraphed-gray, and transparent extra-clear glass Cable Length: 4.92' standard
<b>CCT</b>	2700K, 3000K, 4000K
<b>CRI</b>	CRI >80, CRI >90
<b>BUG Rating</b>	B0-U2-G0 (3000K, 35° sharp) B0-U3-G0 (3000K, 13°, 22°, 30°, 48°, Diffuse)
<b>Delivered Lumens</b>	188 lm (3000K, 22°, CRI 80) 165 lm (3000K, 22°, CRI 90)
<b>Efficacy</b>	94 lm/W (3000K, 22°, CRI 80) 83 lm/W (3000K, 22°, CRI 90)
<b>Optics</b>	6 Standard (see below) <i>The diffused light is made by an opal acrylic under the glass - no optic inside.</i>
<b>Finishes</b>	Glass
<b>Fixture Dimensions</b>	Ø1.89" x 2.48" h
<b>Aperture</b>	Ø1.89"
<b>Fixture Weight</b>	0.44 lbs
<b>LED Source</b>	1 Power LED
<b>Lumen Maintenance</b>	L90,B10>50,000hrs (Ta 25°C)
<b>Color Consistency</b>	1/4 ANSI BIN
<b>Operating Temp.</b>	-4°F to +113°F
<b>IP Rating</b>	IP67
<b>IK Rating</b>	IK08
<b>Driveover</b>	2205 lbs

Fixture Dimensions

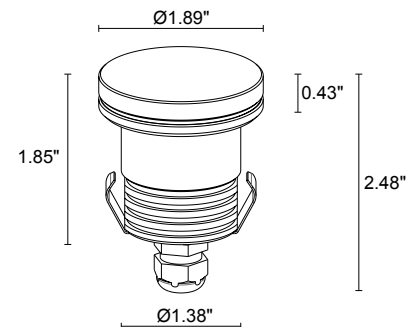

## ORDERING INFORMATION

Example: **LT10100FLNV** or **LT10100FLNV-2**. Accessories / Power Supplies ordered separately.

LT1010				NV	
Model No.	CRI	CCT	Optics	Finish	Cable Length
LT1010	0 - 80 CRI 1 - 90 CRI	F - 2700K 5 - 3000K 9 - 4000K	S - 13° M - 22° F - 30° P - 35° sharp L - 48° D - Diffuse	NV - Glass	4.92' standard 1 - 16.40' 2 - 32.81' 3 - 49.21' 4 - 65.62'

Job Name/Date:

Fixture Type Designation:

## SUGGESTED POWER SUPPLIES

700mA

Part Number	Description	Input/Output	# of Fixtures
<a href="#">PPLT00537</a>	Non-Dim	120-277VAC to 700mA, 4W, Class 2	1-1
<a href="#">PPLT00466-P</a>	0-10V Dimming to 1.0%	120-277VAC to 700mA, 10W, Class 2	1-3
<a href="#">PPLT00498</a>	Phase Dim (120V Only)	120VAC to 700mA, 12W, Class 2	2-4
<a href="#">PPLT00465-P</a>	0-10V Dimming to 1.0%	120-277VAC to 700mA, 20W, Class 2	1-10
<a href="#">PPLT00308-P</a>	0-10V Dimming to 0.1%	120-277VAC to 700mA, 30W, Class 2	1-15
<a href="#">PPLT00480-P</a>	0-10V Dimming to 1.0%	120-277VAC to 700mA, 30W, Class 2	1-15
<a href="#">PPLT00261</a>	Leading/Trailing Edge Dimming to 10% (120V only)	120-277VAC to 700mA, 32W, Class 2	7-12

## Suggested Lutron Compatible

Part Number	Option	Lutron SKU	Dim Range	Description	Input/Output	# of Fixtures
<a href="#">PPLT00515</a>	L3DAE / L3DA3W	L3DA	100%-1%	Hi-Lume™ 1% EcoSystem™ / 3-Wire LED Driver	120-277VAC to 700mA , 14W, Class 2	3-5
<a href="#">PPLT00517</a>	L3DAE / L3DA3W	L3DA	100%-1%	Hi-Lume™ 1% EcoSystem™ / 3.Wire LED Driver	120VAC to 700mA , 27W, Class 2	6-10
<a href="#">PPLT00181</a>	L3DAE / L3DA3W	L3DA	100%-1%	Hi-Lume™ 1% EcoSystem™ / 3-Wire LED Driver	120-277VAC to 700mA, 38W, Class 2	11-15

For other power supply options consult factory.

## ACCESSORIES

### Anti-Glare

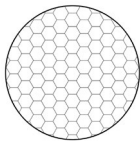

#### WH0100

Honeycomb Louvre  
*Not available for diffuse (D) or 35° sharp (P) optics*

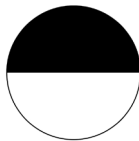

#### WE0600S

Anti-glare lens, half transparent and half serigraphed black  
*Can be fitted on all optics except 48° (L) optic*

### Installation

Ø1.97"



#### WC4010

Outer Casing *For ingrade use*



#### WL0100

Suction cup fixture removal tool

Job Name/Date:

Fixture Type Designation:

## PHOTOMETRIC DATA

Note all Photometry is CRI 80, 3000K

### S - 13° CRI 80

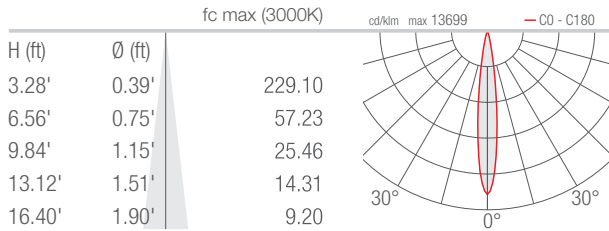

### M - 22° CRI 80

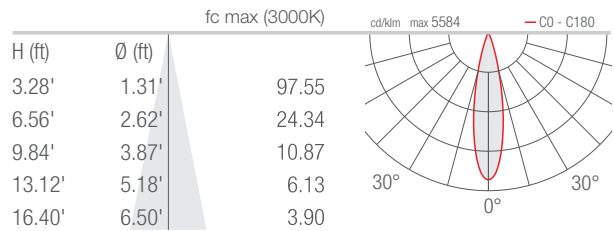

### F - 30° CRI 80

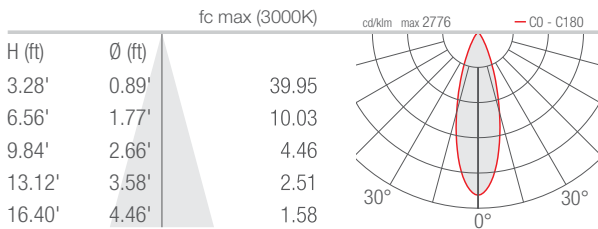

### P - 35° sharp CRI 80

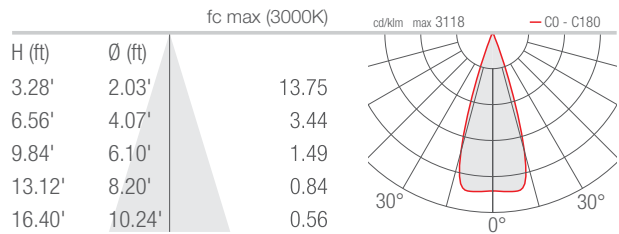

### L - 48° CRI 80

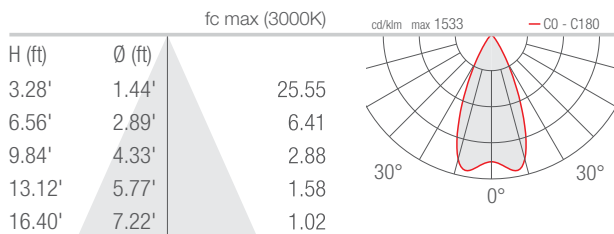

### D - Diffuse CRI 80

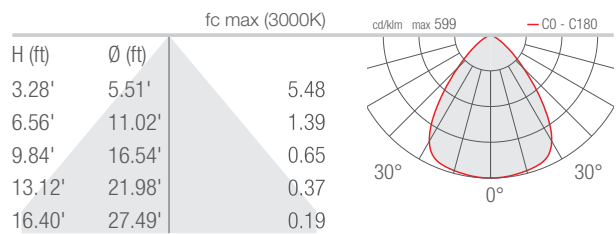

Job Name/Date:

Fixture Type Designation: