

# LITUS 1.6

The Litus 1 series features a sophisticated flush/trimless mount design and with 6 standard optic options are highly versatile for both general and more dynamic lighting. The square version can be used for downlight applications as well.

**The Bright 1, Smoothy 1 and Litus 1 series all use the same LED.**

## TECHNICAL DATA

<b>Wattage / Input</b>	2.5W, 3.5W (24VDC)
<b>Power Supply</b>	Remote, not included. See page 2.
<b>Construction</b>	Body: Aluminum Alloy EN AW 6082 Lens: Tempered, Serigraphed-gray, and Transparent Extra-clear Glass
<b>CCT</b>	2700K, 3000K, 4000K
<b>CRI</b>	CRI >80, CRI >90
<b>BUG Rating</b>	B0-U2-G0 (3000K, 2.5W/3.5W, 35° sharp) B0-U3-G0 (3000K, 2.5W/3.5W, 13°, 22°, 30°, 48°, Diffuse)
<b>Delivered Lumens</b>	See chart - below right
<b>Efficacy</b>	56.4 lm/W (3000K, 2.5W, CRI 80) 50.0 lm/W (3000K, 2.5W, CRI 90) 53.7 lm/W (3000K, 3.5W, CRI 80) 47.1 lm/W (3000K, 3.5W, CRI 90)
<b>Optics</b>	6 Standard (see below) <i>The diffused light is made by an opal acrylic under the glass - no optic inside.</i>
<b>Finishes</b>	Glass
<b>Fixture Dimensions</b>	Ø1.89" x 2.48" h
<b>Aperture</b>	Ø1.89"
<b>Fixture Weight</b>	0.44 lbs
<b>LED Source</b>	1 Power LED
<b>Lumen Maintenance</b>	L90,B10>50,000hrs (Ta 25°C)
<b>Color Consistency</b>	1/4 ANSI BIN
<b>Operating Temp.</b>	-4°F to +113°F
<b>IP Rating</b>	IP67
<b>IK Rating</b>	IK08
<b>Driveover</b>	2205 lbs



Fixture Dimensions

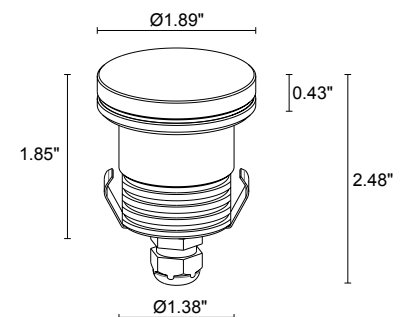

Delivered Lumens (3000K, 22°)	2.5W	3.5W
<b>CRI 80</b>	141 lm	188 lm
<b>CRI 90</b>	125 lm	165 lm

## ORDERING INFORMATION

Example: LT16000FLNV or LT16000FLNV-1. Accessories / Power Supplies ordered separately.

				NV	
Model No.	CRI	CCT	Optics	Finish	Cable Length
LT1600 (2.5W)	0 - 80 CRI	F - 2700K	S - 13°	NV - Glass	4.92' standard
LT1601 (3.5W)	1 - 90 CRI	5 - 3000K	M - 22°		1 - 16.40'
		9 - 4000K	F - 30°		2 - 32.81'
			P - 35° sharp		3 - 49.21'
			L - 48°		4 - 65.62'
			D - Diffuse		

Job Name/Date:

Fixture Type Designation:

## SUGGESTED POWER SUPPLIES

24VDC

Part Number	Description	Input/Output	# of Fixtures 2.5W   3.5W	
<a href="#">PPLT00632</a>	0-10V Dimming (Dim to Off)	120-277VAC to 24VDC, 12W, Class 2	1-3	1-2
<a href="#">PPLT00056</a>	Non-Dim	120-277VAC to 24VDC, 26W, Class 2, IP66	1-8	1-5
<a href="#">PPLT00157</a>	Non-Dim	120VAC to 24VDC, 60W, Class 2	1-19	1-13
<a href="#">PPLT00627</a>	ELV / TRIAC & 0-10V Dimming (100 to 0%), IP67	120-277VAC to 24VDC, 96W, Class 2	1-30	1-21
<a href="#">PPLT00158</a>	Non-Dim	120VAC to 24VDC, 100W, Class 2	1-32	1-22
<a href="#">PPLT00543</a>	0-10V Dimming to 15% (-40°C / -40°F cold weather start)	120-277VAC to 24VDC, 100W, Class 2	4-32	3-22

For other power supply options consult factory.

## ACCESSORIES

### Anti-Glare

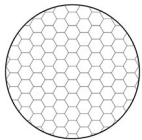

#### WH0100

Honeycomb Louvre  
Can be fitted on all optics  
except for 48° (L) optic

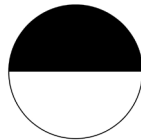

#### WE0600S

Anti-glare lens, half trans-  
parent and half serigraphed  
black  
Can be fitted on all optics  
except for 48° (L) optic

## ACCESSORIES

### Installation



#### WC4010

Outer Casing  
For ingrade use



#### WL0100

Suction cup fixture  
removal tool

Job Name/Date:

Fixture Type Designation:

## PHOTOMETRIC DATA

Note all Photometry is CRI 80, 3000K

### S - 13° CRI 80

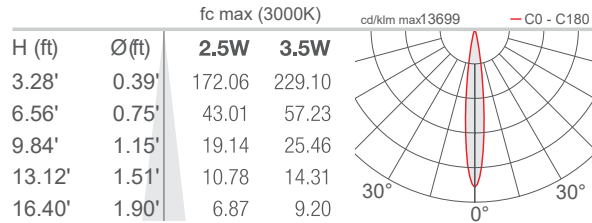

### M - 22° CRI 80

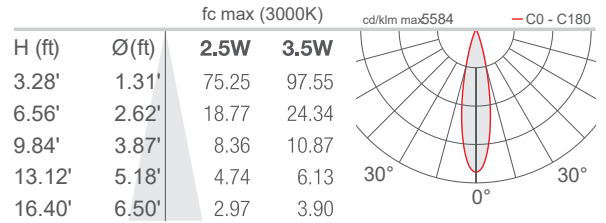

### F - 30° CRI 80

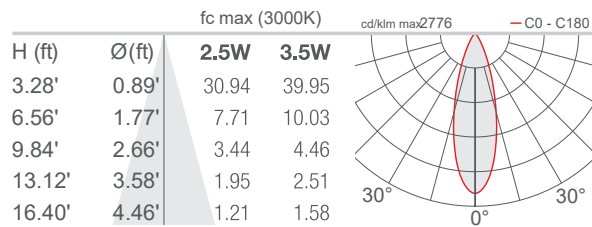

### P - 35° sharp CRI 80

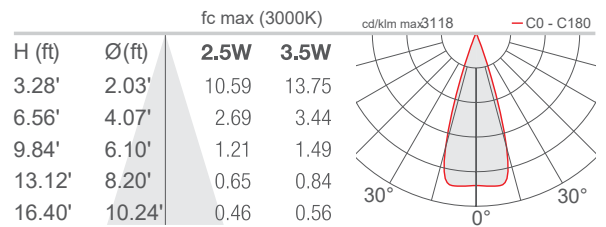

### L - 48° CRI 80

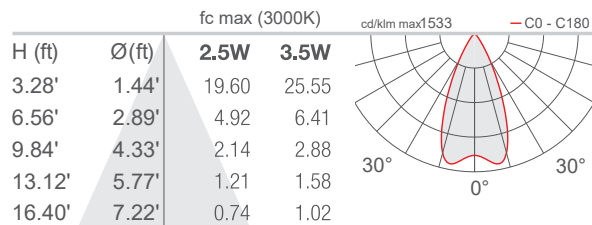

### D - Diffuse CRI 80 (Litus 1.6 / 1.7)

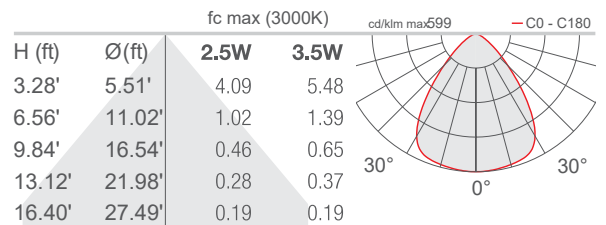

Job Name/Date:

Fixture Type Designation: