

LITUS 1.6

The Litus 1 series features a sophisticated flush/trimless mount design and with 6 standard optic options are highly versatile for both general and more dynamic lighting. The square version can be used for downlight applications as well.

The Bright 1, Smoothy 1 and Litus 1 series all use the same LED.

TECHNICAL DATA

Wattage / Input	2.5W, 3.5W (24VDC)
Power Supply	Remote, not included. See page 2.
Construction	Body: Aluminum Alloy EN AW 6082 Lens: Tempered, Serigraphed-gray, and Transparent Extra-clear Glass
CCT	2700K, 3000K, 4000K
CRI	CRI >80, CRI >90
BUG Rating	B0-U2-G0 (3000K, 2.5W/3.5W, 35° sharp) B0-U3-G0 (3000K, 2.5W/3.5W, 13°, 22°, 30°, 48°, Diffuse)
Delivered Lumens	See chart - below right
Efficacy	56.4 lm/W (3000K, 2.5W, CRI 80) 50.0 lm/W (3000K, 2.5W, CRI 90) 53.7 lm/W (3000K, 3.5W, CRI 80) 47.1 lm/W (3000K, 3.5W, CRI 90)
Optics	6 Standard (see below) <i>The diffused light is made by an opal acrylic under the glass - no optic inside.</i>
Finishes	Glass
Fixture Dimensions	Ø1.89" x 2.48" h
Aperture	Ø1.89"
Fixture Weight	0.44 lbs
LED Source	1 Power LED
Lumen Maintenance	L90,B10>50,000hrs (Ta 25°C)
Color Consistency	1/4 ANSI BIN
Operating Temp.	-4°F to +113°F
IP Rating	IP67
IK Rating	IK08
Driveover	2205 lbs



Fixture Dimensions

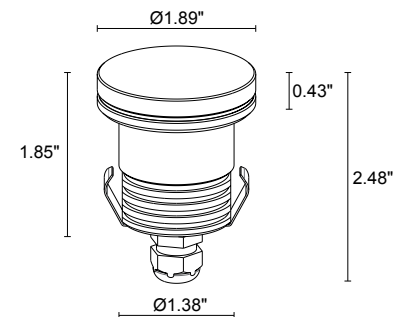

Delivered Lumens (3000K, 22°)	2.5W	3.5W
CRI 80	141 lm	188 lm
CRI 90	125 lm	165 lm

ORDERING INFORMATION

Example: LT16000FLNV or LT16000FLNV-1. Accessories / Power Supplies ordered separately.

				NV	
Model No.	CRI	CCT	Optics	Finish	Cable Length
LT1600 (2.5W)	0 - 80 CRI	F - 2700K	S - 13°	NV - Glass	4.92' standard
LT1601 (3.5W)	1 - 90 CRI	5 - 3000K	M - 22°		1 - 16.40'
		9 - 4000K	F - 30°		2 - 32.81'
			P - 35° sharp		3 - 49.21'
			L - 48°		4 - 65.62'
			D - Diffuse		

Job Name/Date:

Fixture Type Designation:

SUGGESTED POWER SUPPLIES

24VDC

Part Number	Description	Input/Output	# of Fixtures	
			2.5W	3.5W
PPLT00632	0-10V Dimming (Dim to Off)	120-277VAC to 24VDC, 12W, Class 2	1-3	1-2
PPLT00586	Non-Dim	120-277VAC to 24VDC, 40W, Class 2	1-12	1-9
PPLT00709	ELV / TRIAC & 0-10V Dimming	120-277VAC to 24VDC, 96W, Class 2, DAMP	1-30	1-21
PPLT00543	0-10V Dimming to 15% (-40°C / -40°F cold weather start)	120-277VAC to 24VDC, 100W, Class 2	4-32	3-22

Suggested Lutron Compatible

Part Number	Option	Lutron SKU	Dim Range	Description	Input/Output	# of Fixtures	
						2.5W	3.5W
PPLT00273	L3DAE / L3DA3W	L3DA	100%-1%	Hi-Lume™ 1% EcoSystem™ or 1% 3-Wire LED Driver	120-277VAC to 24VDC, 40W, Class 2	1-12	1-9
PPLT00530	L3DAE / L3D0	L3DA/L3D0	100%-1%	Hi-Lume™ 0.1% EcoSystem™ or 3-Wire LED Driver	120-277VAC to 24VDC, 96W, Class 2	1-30	1-21

For other power supply options consult factory.

ACCESSORIES

Anti-Glare

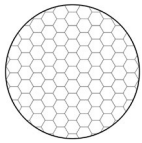

WH0100

Honeycomb Louvre
Can be fitted on all optics
except for 48° (L) optic

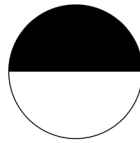

WE0600S

Anti-glare lens, half trans-
parent and half serigraphed
black
Can be fitted on all optics
except for 48° (L) optic

ACCESSORIES

Installation



WC4010

Outer Casing
For ingrade use



WL0100

Suction cup fixture
removal tool

Job Name/Date:

Fixture Type Designation:

PHOTOMETRIC DATA

Note all Photometry is CRI 80, 3000K

S - 13° CRI 80

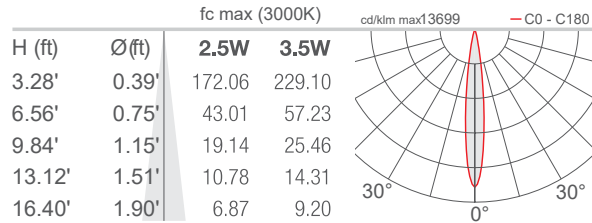

M - 22° CRI 80

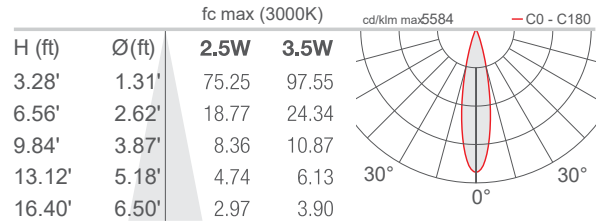

F - 30° CRI 80

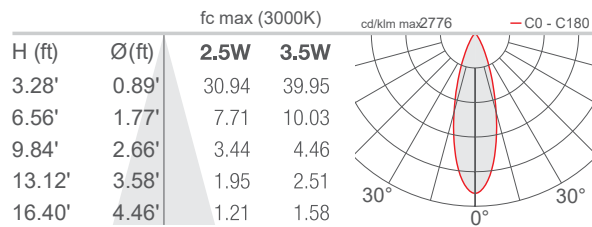

P - 35° sharp CRI 80

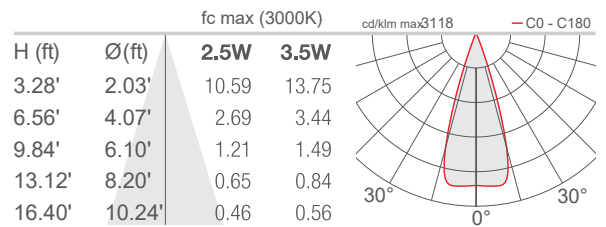

L - 48° CRI 80

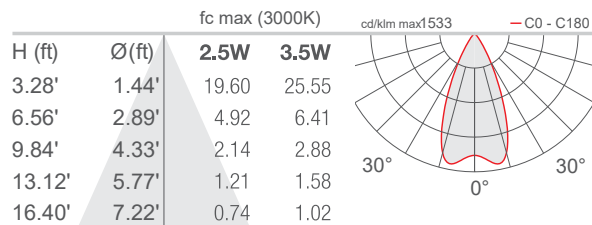

D - Diffuse CRI 80 (Litus 1.6 / 1.7)

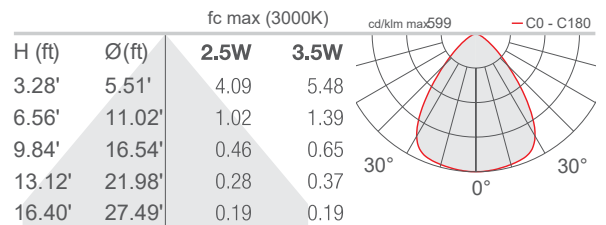

Job Name/Date:

Fixture Type Designation: