

LITUS 1.7

The Litus 1 series features a sophisticated flush/trimless mount design and with 6 standard optic options are highly versatile for both general and more dynamic lighting. The square version can be used for downlight applications as well. **The Bright 1, Smoothy 1 and Litus 1 series all use the same LED.**



TECHNICAL DATA

Wattage / Input	2.5W, 3.5W (24VDC)
Power Supply	Remote, not included. See page 2.
Construction	Body: Aluminum Alloy EN AW 6082 Lens: Tempered, Serigraphed-gray, and Transparent Extra-clear Glass
CCT	2700K, 3000K, 4000K
CRI	CRI >80, CRI >90
BUG Rating	B0-U2-G0 (3000K, 2.5W/3.5W, 35° sharp) B0-U3-G0 (3000K, 2.5W/3.5W, 13°, 22°, 30°, 48°, D)
Delivered Lumens	See chart - below right
Efficacy	56.4 lm/W (3000K, 2.5W, CRI 80) 50.0 lm/W (3000K, 2.5W, CRI 90) 53.7 lm/W (3000K, 3.5W, CRI 80) 47.1 lm/W (3000K, 3.5W, CRI 90)
Optics	6 Standard (see below) <i>The diffused light is made by an opal acrylic under the glass - no optic inside.</i>
Finishes	Glass
Fixture Dimensions	1.85" x 1.85" x 2.48"
Cut-out Size	1.89" x 1.89" (for ceiling installations)
Fixture Weight	0.44 lbs
LED Source	1 Power LED
Lumen Maintenance	L90,B10>50,000hrs (Ta 25°C)
Color Consistency	1/4 ANSI BIN
Operating Temp.	-4°F to +113°F
IP Rating	IP67
IK Rating	IK08
Driveover	2205 lbs

Fixture Dimensions

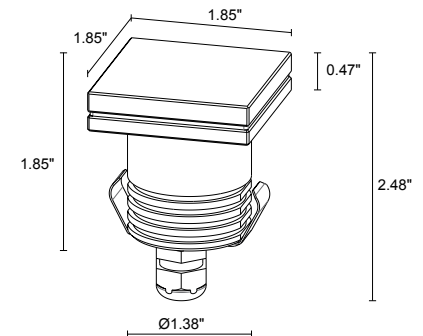

Delivered Lumens (3000K, 22°)	2.5W	3.5W
CRI 80	141 lm	188 lm
CRI 90	125 lm	165 lm

ORDERING INFORMATION

Example: **LT17000FLNV** or **LT17000FLNV-2**. Accessories / Power Supplies ordered separately.

Model No.	CRI	CCT	Optics	Finish	Cable Length
LT1700 (2.5W)	0 - 80 CRI	F - 2700K	S - 13°	NV - Glass	4.92' standard
LT1701 (3.5W)	1 - 90 CRI	5 - 3000K 9 - 4000K	M - 22° F - 30° P - 35° sharp L - 48° D - Diffuse		1 - 16.40' 2 - 32.81' 3 - 49.21' 4 - 65.62'

Job Name/Date:

Fixture Type Designation:

SUGGESTED POWER SUPPLIES

24VDC

Part Number	Description	Input/Output	# of Fixtures	
			2.5W	3.5W
PPLT00632	0-10V Dimming (Dim to Off)	120-277VAC to 24VDC, 12W, Class 2	1-3	1-2
PPLT00056	Non-Dim	120-277VAC to 24VDC, 26W, Class 2, IP66	1-8	1-5
PPLT00157	Non-Dim	120VAC to 24VDC, 60W, Class 2	1-19	1-13
PPLT00627	ELV / TRIAC & 0-10V Dimming (100 to 0%), IP67	120-277VAC to 24VDC, 96W, Class 2	1-30	1-21
PPLT00158	Non-Dim	120VAC to 24VDC, 100W, Class 2	1-32	1-22
PPLT00543	0-10V Dimming to 15% (-40°C / -40°F cold weather start)	120-277VAC to 24VDC, 100W, Class 2	4-32	3-22

For other power supply options consult factory.

ACCESSORIES

Anti-Glare



WE0601S

Anti-glare lens, half transparent and half serigraphed black
**can be fitted on all optics except 48° (L) optic*

ACCESSORIES

Installation

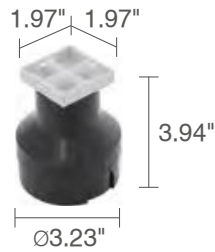

WC4011

Outer Casing
 For ingrade use

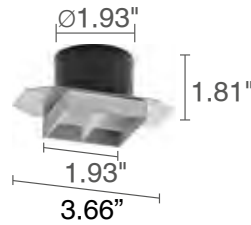

WC4511

Outer Casing
 For plasterboard/
 ceiling use



WL0100

Suction cup fixture
 removal tool

Job Name/Date:

Fixture Type Designation:

PHOTOMETRIC DATA

Note all Photometry is CRI 80, 3000K

S - 13° CRI 80

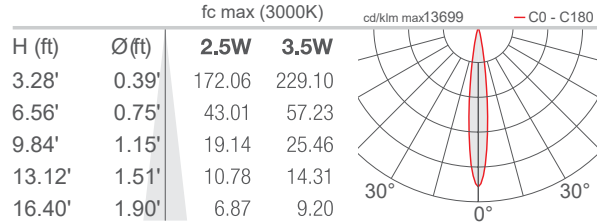

M - 22° CRI 80

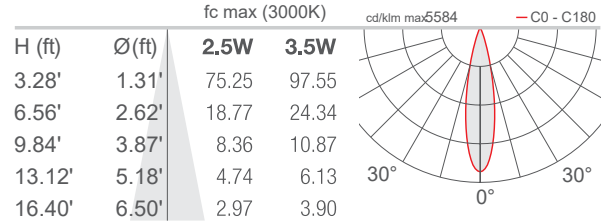

F - 30° CRI 80

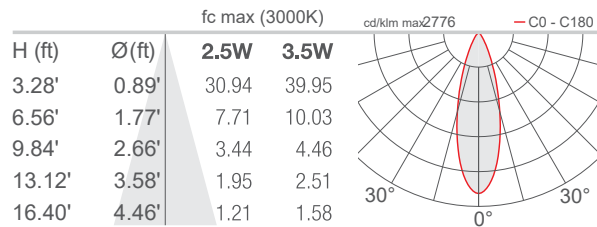

P - 35° sharp CRI 80

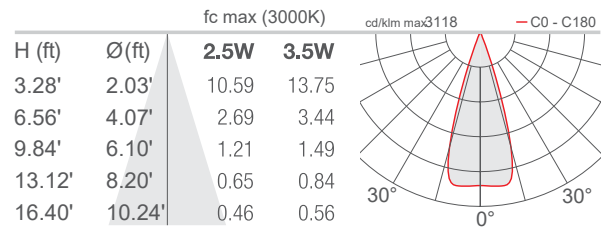

L - 48° CRI 80

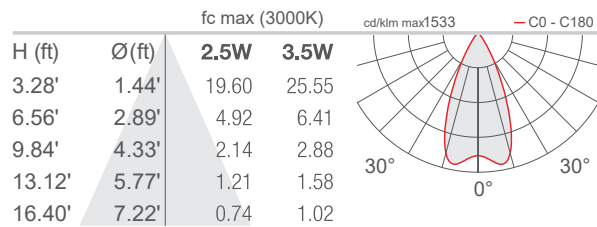

D - Diffuse CRI 80 (Litus 1.6 / 1.7)

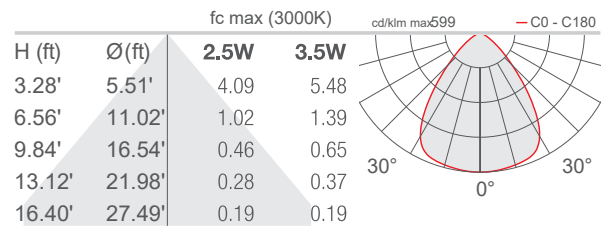

Job Name/Date:

Fixture Type Designation: