

# LITUS 2.4

The Litus 2 series features a sophisticated flush/trimless mount design with a wide selection of optic options. These fixtures are highly versatile for both general and more dynamic lighting. The square version can be used for downlight applications as well. **The Bright 2, Smoothy 2 and Litus 2 series all use the same LED.**



## TECHNICAL DATA

<b>Wattage / Input</b>	3.5W, 5W, 7W (24VDC); 7W RGB (700mA)
<b>Power Supply</b>	Remote, not included. See page 2.
<b>Construction</b>	Body: Aluminum alloy EN AW 6082 Lens: Tempered, serigraphed-gray, and transparent extra-clear glass
<b>CCT</b>	2700K, 3000K, 4000K, RGB (3500K on request, consult factory)
<b>CRI</b>	>80, >90
<b>BUG Rating</b>	B0-U3-G0 (3000K, All versions)
<b>Delivered Lumens</b>	See chart - below right for static white RGB: 235 lm: (R) 92 lm, (G) 105 lm, (B) 38 lm
<b>Efficacy</b>	70.4 lm/W (5W,CRI 80), 56.8 lm/W (5W,CRI 90) 66.1 lm/W (7W,CRI 80), 53.4 lm/W (7W,CRI 90) 33.6 lm/W (RGB)
<b>Optics</b>	10 Standard (White), 4 Standard (RGB) <i>The diffused light is made by an opal acrylic under the glass - no optic inside.</i>
<b>Finishes</b>	Glass
<b>Fixture Dimensions</b>	Ø2.83" x 2.87" I
<b>Fixture Weight</b>	0.77 lbs
<b>LED Source</b>	1 High Intensity Power LED; RGB: 3 Power LEDs
<b>Lumen Maintenance</b>	L90,B10>50,000hrs (Ta 25°C)
<b>Color Consistency</b>	1/4 ANSI BIN
<b>Operating Temp.</b>	-4°F to +113°F
<b>IP Rating</b>	IP67
<b>IK Rating</b>	IK08
<b>Driveover</b>	2205 lbs

Fixture Dimensions

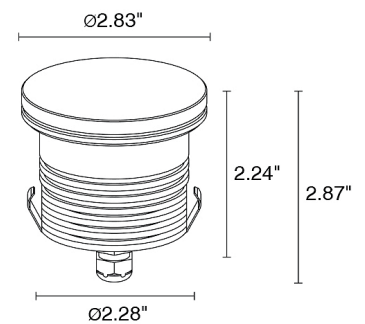

Delivered Lumens (3000K, 34°)	5W	7W
<b>CRI 80</b>	352 lm	463 lm
<b>CRI 90</b>	284 lm	374 lm

## ORDERING INFORMATION

Example: LT24010FLNV or LT24010FLNV-1. Accessories / Power Supplies ordered separately.

Model #	Wattage	CRI	CCT	Optics	Finish	Cable Length
LT240	0 - 3.5W (5°, 80CRI, 4000K only) 1 - 5W 2 - 7W	0 - 80 CRI 1 - 90 CRI	F - 2700K 5 - 3000K 9 - 4000K	U - 5° (3.5W only)    M - 34°	NV - Glass	4.92' standard 1 - 16.40' 2 - 32.81' 3 - 49.21' 4 - 65.62'
				V - 8°    L - 45°		
				T - 11°    Q - 61° sharp		
				S - 17°    W - 13°x52°		
LT243	2 - 7W	6 - RGB	6 - RGB	P - 21° sharp    D - Diffuse		
				S - 20°    L - 45°		
				M - 34°    W - 21°x42°		

Job Name/Date:

Fixture Type Designation:

## SUGGESTED POWER SUPPLIES

24VDC

Part Number	Description	Input/Output	# of Fixtures		
			3.5W	5W	7W
<a href="#">PPLT00632</a>	0-10V Dimming (Dim to Off)	120-277VAC to 24VDC, 12W, Class 2	1-2	1-1	1-1
<a href="#">PPLT00056</a>	Non-Dim	120-277VAC to 24VDC, 26W, Class 2, IP66	1-5	1-4	1-2
<a href="#">PPLT00157</a>	Non-Dim	120VAC to 24VDC, 60W, Class 2	1-13	1-9	1-6
<a href="#">PPLT00627</a>	ELV / TRIAC & 0-10V Dimming (100 to 0%), IP67	120-277VAC to 24VDC, 96W, Class 2	1-21	1-15	1-10
<a href="#">PPLT00158</a>	Non-Dim	120VAC to 24VDC, 100W, Class 2	1-22	1-16	1-11
<a href="#">PPLT00543</a>	0-10V Dimming to 15% (-40°C / -40°F cold weather start)	120-277VAC to 24VDC, 100W, Class 2	3-22	2-16	2-11

700mA - RGB

Part Number	Description	Input/Output	# of Fixtures
			7W
<a href="#">PPLT00244-P</a>	DMX / RDM (Must advise DMX addresses if not using RDM)	120-277VAC to 700mA, 50W, Class 2	1-5
<a href="#">PPLT00129-P</a>	DMX / RDM (Field Addressable)	120-277VAC to 700mA, 100W, Class 2	1-9

For other power supply options consult factory.

## ACCESSORIES

### Anti-Glare

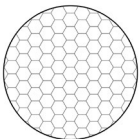

**WH0203**

Honeycomb Louvre

*Not available for sharp (P, Q), diffuse (D) or 13°x52° (W) optics*

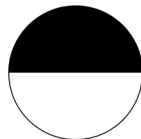

**WE0602S**

Anti-glare lens, half transparent and half serigraphed black

*\*Can be fitted on all optics except for RGB version*

## ACCESSORIES

### Installation



**WC4020**

Outer Casing  
*For ingrade use*



**WL0100**

Suction cup fixture removal tool

Job Name/Date:

Fixture Type Designation:

## PHOTOMETRIC DATA

Note all Photometry is CRI 80, 3000K

### U - 5° CRI 80

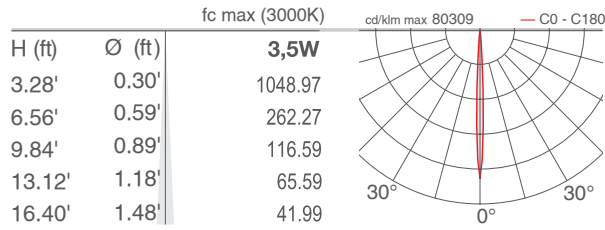

### V - 8° CRI 80

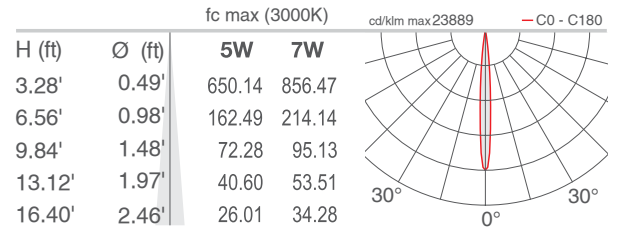

### T - 11° CRI 80

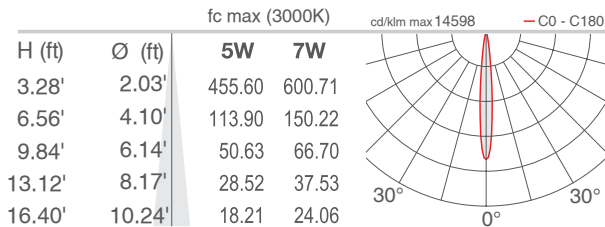

### S - 17° CRI 80

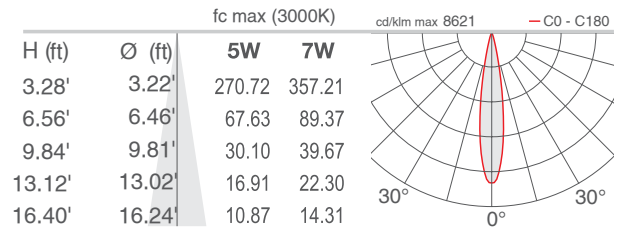

### P - 21° sharp CRI 80

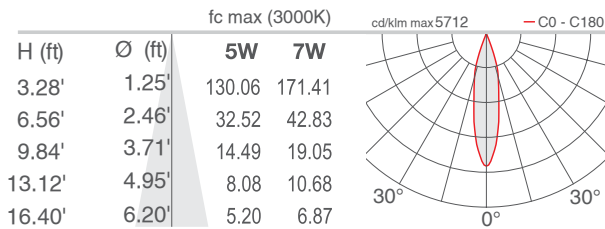

### M - 34° CRI 80

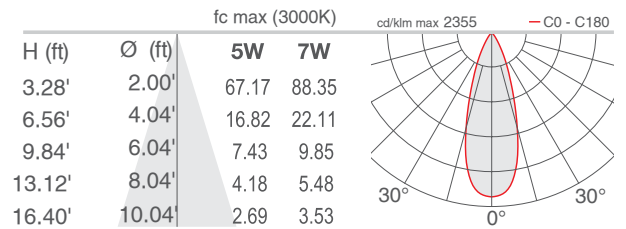

### L - 45° CRI 80

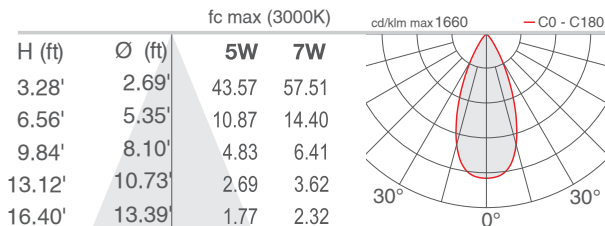

### Q - 61° sharp CRI 80

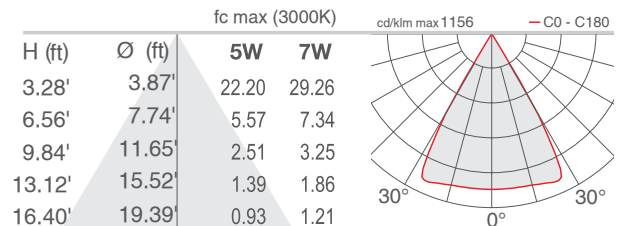

### W - 13°x52° CRI 80

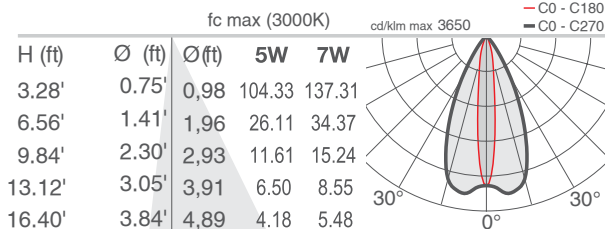

### D - Diffuse CRI 80 (Litus 2.4 / 2.5)

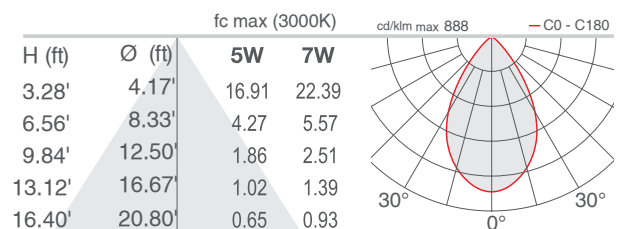

Job Name/Date:

Fixture Type Designation: