

LITUS 2.4

The Litus 2 series features a sophisticated flush/trimless mount design with a wide selection of optic options. These fixtures are highly versatile for both general and more dynamic lighting. The square version can be used for downlight applications as well. **The Bright 2, Smoothy 2 and Litus 2 series all use the same LED.**



TECHNICAL DATA

Wattage / Input	3.5W, 5W, 7W (24VDC); 7W RGB (700mA)
Power Supply	Remote, not included. See page 2.
Construction	Body: Aluminum alloy EN AW 6082 Lens: Tempered, serigraphed-gray, and transparent extra-clear glass
CCT	2700K, 3000K, 4000K, RGB (3500K on request, consult factory)
CRI	>80, >90
BUG Rating	B0-U3-G0 (3000K, All versions)
Delivered Lumens	See chart - below right for static white RGB: 235 lm: (R) 92 lm, (G) 105 lm, (B) 38 lm
Efficacy	70.4 lm/W (5W,CRI 80), 56.8 lm/W (5W,CRI 90) 66.1 lm/W (7W,CRI 80), 53.4 lm/W (7W,CRI 90) 33.6 lm/W (RGB)
Optics	10 Standard (White), 4 Standard (RGB) <i>The diffused light is made by an opal acrylic under the glass - no optic inside.</i>
Finishes	Glass
Fixture Dimensions	Ø2.83" x 2.87" I
Fixture Weight	0.77 lbs
LED Source	1 High Intensity Power LED; RGB: 3 Power LEDs
Lumen Maintenance	L90,B10>50,000hrs (Ta 25°C)
Color Consistency	1/4 ANSI BIN
Operating Temp.	-4°F to +113°F
IP Rating	IP67
IK Rating	IK08
Driveover	2205 lbs

Fixture Dimensions

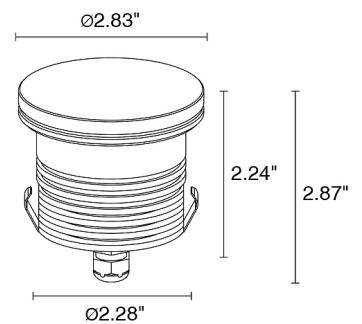

Delivered Lumens (3000K, 34°)	5W	7W
CRI 80	352 lm	463 lm
CRI 90	284 lm	374 lm

ORDERING INFORMATION

Example: LT24010FLNV or LT24010FLNV-1. Accessories / Power Supplies ordered separately.

Model #	Wattage	CRI	CCT	Optics	Finish	Cable Length
LT240	0 - 3.5W (5°, 80CRI, 4000K only) 1 - 5W 2 - 7W	0 - 80 CRI 1 - 90 CRI	F - 2700K 5 - 3000K 9 - 4000K	U - 5° (3.5W only) M - 34°	NV - Glass	4.92' standard 1 - 16.40' 2 - 32.81' 3 - 49.21' 4 - 65.62'
				V - 8° L - 45°		
				T - 11° Q - 61° sharp		
				S - 17° W - 13°x52°		
LT243	2 - 7W	CCT	6 - RGB	P - 21° sharp D - Diffuse		
				S - 20° L - 45°		
				M - 34° W - 21°x42°		

Job Name/Date:

Fixture Type Designation:

SUGGESTED POWER SUPPLIES

24VDC

Part Number	Description	Input/Output	# of Fixtures		
			3.5W	5W	7W
PPLT00632	0-10V Dimming (Dim to Off)	120-277VAC to 24VDC, 12W, Class 2	1-2	1-1	1-1
PPLT00056	Non-Dim	120-277VAC to 24VDC, 26W, Class 2, IP66	1-5	1-4	1-2
PPLT00586	Non-Dim	120-277VAC to 24VDC, 40W, Class 2	1-9	1-6	1-4
PPLT00158	Non-Dim	120VAC to 24VDC, 100W, Class 2	1-22	1-16	1-11
PPLT00543	0-10V Dimming to 15% (-40°C / -40°F cold weather start)	120-277VAC to 24VDC, 100W, Class 2	3-22	2-16	2-11

Suggested Lutron Compatible

Part Number	Option	Lutron SKU	Dim Range	Description	Input/Output	# of Fixtures		
						3.5W	5W	7W
PPLT00273	L3DAE / L3DA3W	L3DA	100%-1%	Hi-Lume™ 1% EcoSystem™ or 1% 3-Wire LED Driver	120-277VAC to 24VDC, 40W, Class 2	1-9	1-6	1-4
PPLT00530	L3DAE / L3D0	L3DA/L3D0	100%-1%	Hi-Lume™ 0.1% EcoSystem™ or 3-Wire LED Driver	120-277VAC to 24VDC, 96W, Class 2	1-21	1-15	1-10

700mA - RGB

Part Number	Description	Input/Output	# of Fixtures		
			3.5W	5W	7W
PPLT00244-P	DMX / RDM (Must advise DMX addresses if not using RDM)	120-277VAC to 700mA, 50W, Class 2	1-5		
PPLT00129-P	DMX / RDM (Field Addressable)	120-277VAC to 700mA, 100W, Class 2	1-9		

For other power supply options consult factory.

ACCESSORIES

Anti-Glare

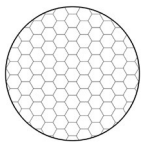

WH0203

Honeycomb Louvre

Not available for sharp (P, Q), diffuse (D) or 13°x52° (W) optics

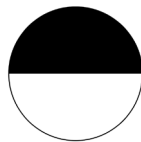

WE0602S

Anti-glare lens, half transparent and half serigraphed black

***Can be fitted on all optics except for RGB version**

ACCESSORIES

Installation



WC4020

Outer Casing
For in-grade use



WL0100

Suction cup fixture removal tool

Job Name/Date:

Fixture Type Designation:

PHOTOMETRIC DATA

Note all Photometry is CRI 80, 3000K

U - 5° CRI 80

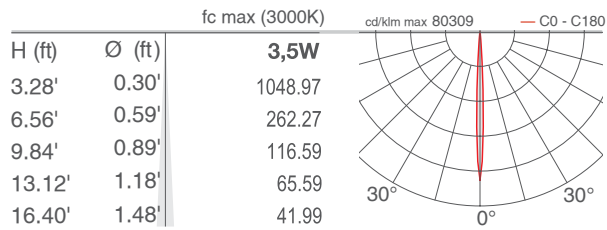

V - 8° CRI 80

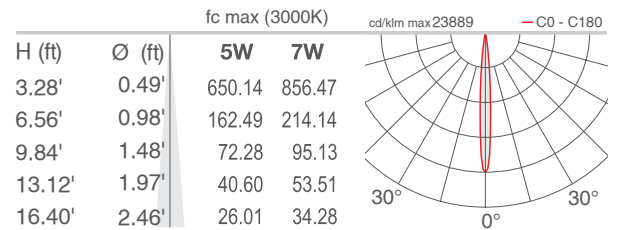

T - 11° CRI 80

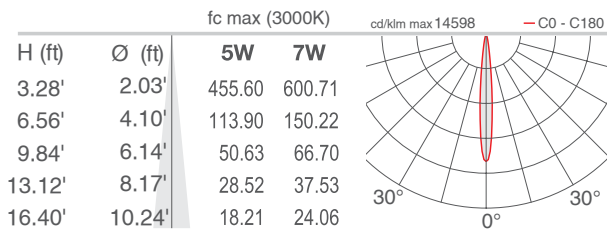

S - 17° CRI 80

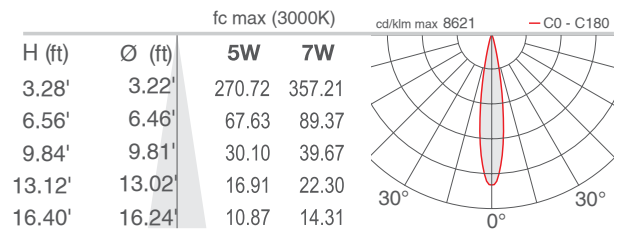

P - 21° sharp CRI 80

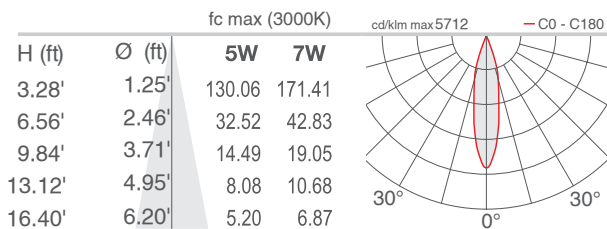

M - 34° CRI 80

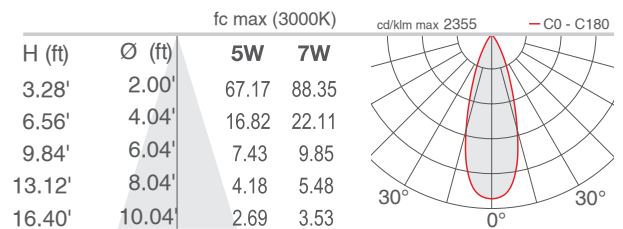

L - 45° CRI 80

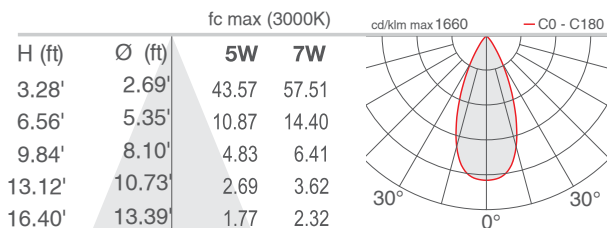

Q - 61° sharp CRI 80

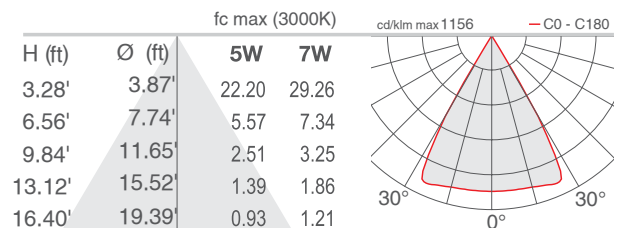

W - 13°x52° CRI 80

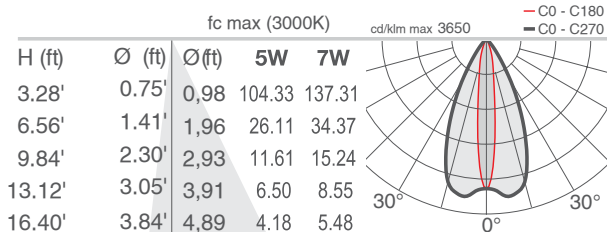

D - Diffuse CRI 80 (Litus 2.4 / 2.5)

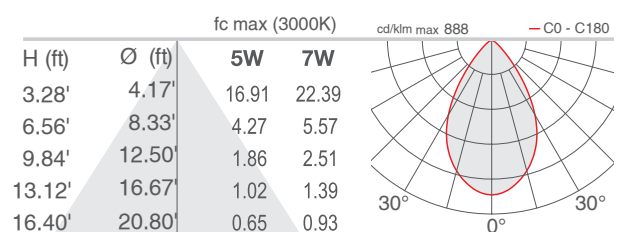

Job Name/Date:

Fixture Type Designation: