

LITUS 2.5

The Litus 2 series features a sophisticated flush/trimless mount design with a wide selection of optic options. These fixtures are highly versatile for both general and more dynamic lighting. The square version can be used for downlight applications as well.

The Bright 2, Smoothy 2 and Litus 2 series all use the same LED.

TECHNICAL DATA

Wattage / Input	3.5W, 5W, 7W (24VDC); 7W RGB (700mA)
Power Supply	Remote, not included. See page 2.
Construction	Body: Aluminum alloy EN AW 6082 Lens: Tempered, serigraphed-gray, and transparent extra-clear glass
CCT	2700K, 3000K, 4000K, RGB (3500K on request, consult factory)
CRI	CRI >80, CRI >90
BUG Rating	B0-U3-G0 (3000K, all versions)
Delivered Lumens	See chart - below right for static white RGB: 235 lm: (R) 92 lm, (G) 105 lm, (B) 38 lm
Efficacy	70.4 lm/W (5W, CRI 80), 56.8 lm/W (5W, CRI 90) 66.1 lm/W (7W, CRI 80), 53.4 lm/W (7W, CRI 90) 33.6 lm/W (RGB)
Optics	10 Standard (white), 4 Standard (RGB) <i>The diffused light is made by an opal acrylic under the glass - no optic inside.</i>
Finishes	Glass
Fixture Dimensions	2.80" w x 2.80" h x 2.91" l
Fixture Weight	0.82 lbs
LED Source	1 High Intensity Power LED; RGB: 3 Power LEDs
Lumen Maintenance	L90, B10 > 50,000hrs (Ta 25°C)
Color Consistency	1/4 ANSI BIN
Operating Temp.	-4°F to +113°F
IP Rating	IP67
IK Rating	IK08
Driveover	2205 lbs



Fixture Dimensions

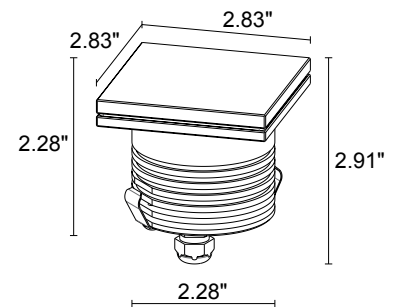

Delivered Lumens (3000K, 34°)	5W	7W
CRI 80	352 lm	463 lm
CRI 90	284 lm	374 lm

ORDERING INFORMATION

Example: LT25010FLNV or LT25010FLNV-1. Accessories / Power Supplies ordered separately.

Model #	Wattage	CRI	CCT	Optics	Finish	Cable Length
LT250	0 - 3.5W (5°, 80CRI, 4000K only) 1 - 5W 2 - 7W	0 - 80 CRI 1 - 90 CRI	F - 2700K 5 - 3000K 9 - 4000K	U - 5° (3.5W only)	NV - Glass	4.92' standard 1 - 16.40' 2 - 32.81' 3 - 49.21' 4 - 65.62'
				M - 34°		
				V - 8°		
				L - 45°		
LT253	2 - 7W	6 - RGB	6 - RGB	T - 11°	NV - Glass	4.92' standard 1 - 16.40' 2 - 32.81' 3 - 49.21' 4 - 65.62'
				Q - 61° sharp		
				S - 17°		
				W - 13°x52°		
LT253	2 - 7W	6 - RGB	6 - RGB	P - 21° sharp	NV - Glass	4.92' standard 1 - 16.40' 2 - 32.81' 3 - 49.21' 4 - 65.62'
				D - Diffuse		
				S - 20°		
				M - 34°		
LT253	2 - 7W	6 - RGB	6 - RGB	W - 21°x42°	NV - Glass	4.92' standard 1 - 16.40' 2 - 32.81' 3 - 49.21' 4 - 65.62'
				L - 45°		
				M - 34°		
				W - 21°x42°		

Job Name/Date:

Fixture Type Designation:

SUGGESTED POWER SUPPLIES

24VDC

Part Number	Description	Input/Output	# of Fixtures		
			3.5W / 5W	5W / 7W	7W
PPLT00632	0-10V Dimming (Dim to Off)	120-277VAC to 24VDC, 12W, Class 2	1-2	1-1	1-1
PPLT00056	Non-Dim	120-277VAC to 24VDC, 26W, Class 2, IP66	1-5	1-4	1-2
PPLT00157	Non-Dim	120VAC to 24VDC, 60W, Class 2	1-13	1-9	1-6
PPLT00627	ELV / TRIAC & 0-10V Dimming (100 to 0%), IP67	120-277VAC to 24VDC, 96W, Class 2	1-21	1-15	1-10
PPLT00158	Non-Dim	120VAC to 24VDC, 100W, Class 2	1-22	1-16	1-11
PPLT00543	0-10V Dimming to 15% (-40°C / -40°F cold weather start)	120-277VAC to 24VDC, 100W, Class 2	3-22	2-16	2-11

700mA - RGB

Part Number	Description	Input/Output	# of Fixtures 7W
PPLT00244-P	DMX / RDM (Must advise DMX addresses if not using RDM)	120-277VAC to 700mA, 50W, Class 2	1-5
PPLT00129-P	DMX / RDM (Field Addressable)	120-277VAC to 700mA, 100W, Class 2	1-9

For other power supply options consult factory.

ACCESSORIES

Anti-Glare

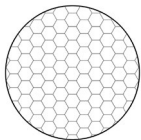

WH0203

Honeycomb Louvre
Not available for sharp (P & Q), diffuse (D) or 13°x52° (W) optics



WE0603S

Anti-glare lens, half transparent and half serigraphed black
Can be fitted on all optics except for RGB version

ACCESSORIES

Installation



WC4021

Outer Casing
For ingrade use

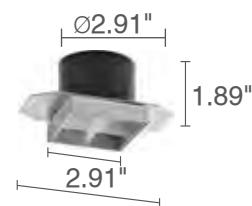

WC4521

Outer Casing
For plasterboard



WL0100

Suction cup fixture removal tool

Job Name/Date:

Fixture Type Designation:

PHOTOMETRIC DATA

Note all Photometry is CRI 80, 3000K

U - 5° CRI 80

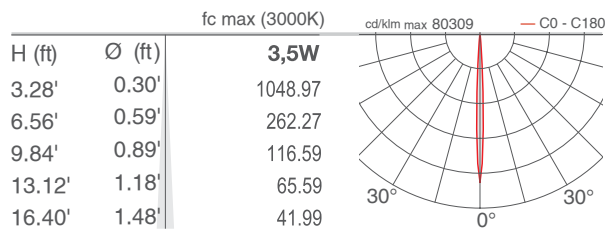

V - 8° CRI 80

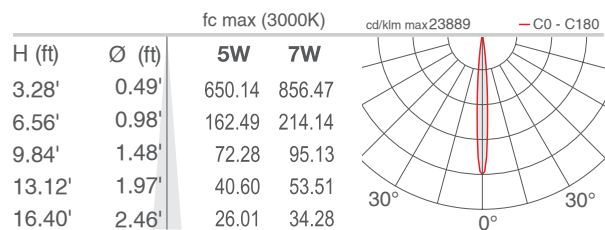

T - 11° CRI 80

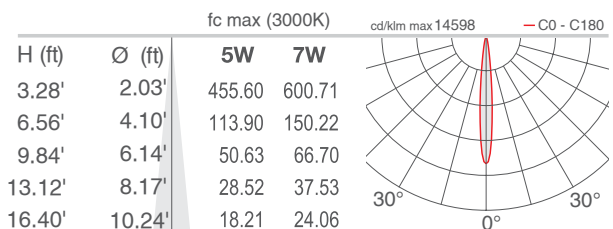

S - 17° CRI 80

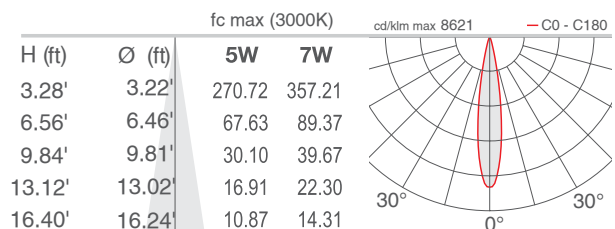

P - 21° sharp CRI 80

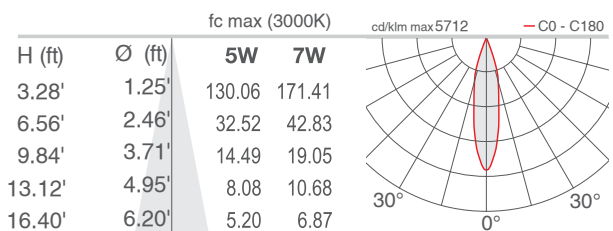

M - 34° CRI 80

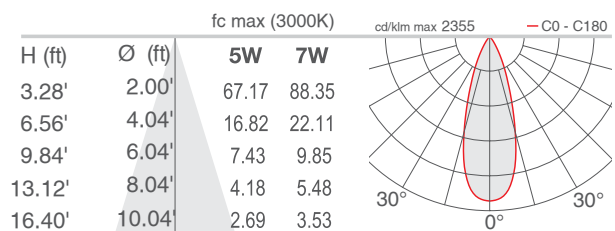

L - 45° CRI 80

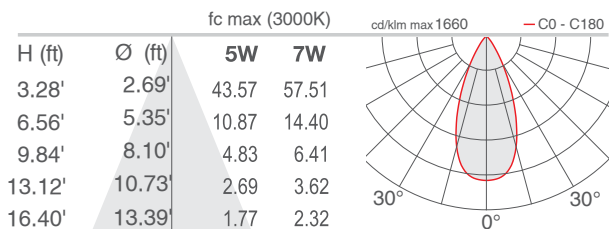

Q - 61° sharp CRI 80

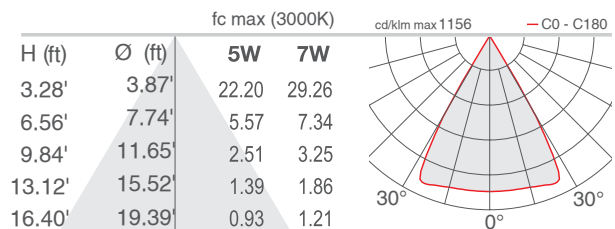

W - 13°x52° CRI 80

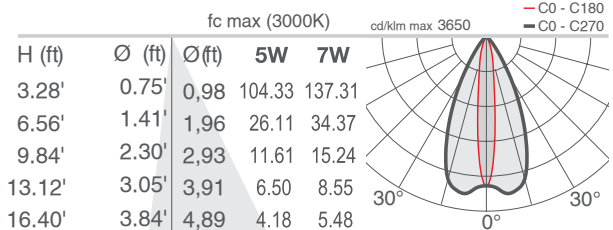

D - Diffuse CRI 80 (Litus 2.4 / 2.5)

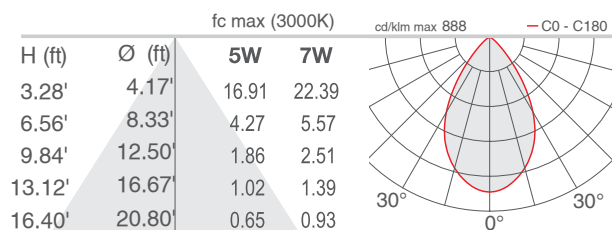

Job Name/Date:

Fixture Type Designation: