

LITUS 5.4

The Litus 5 series features a sophisticated flush/trimless mount design. With a wide selection of optic options, these fixtures are highly versatile for general and more dynamic lighting. The square version can be used for downlight applications as well. **The Bright 3, Smoothy 5 and Litus 5 series all use the same LED.**

TECHNICAL DATA

| | |
|---------------------------|--|
| Wattage / Input | 10W, 13W (24VDC) |
| Power Supply | Remote, not included. See page 2. |
| Construction | Body: Aluminum Alloy EN AW 6082 Lens: Tempered, Serigraphed-gray, and Transparent Extra-clear Glass |
| CCT | 2700K, 3000K, 4000K |
| CRI | CRI >80, CRI >90 |
| Delivered Lumens | See chart - below right |
| Efficacy | 80 lm/W (3000K, 10W, CRI 80) 65 lm/W (3000K, 10W, CRI 90) 82 lm/W (3000K, 13W, CRI 80) 66 lm/W (3000K, 13W, CRI 90) |
| Optics | 7 Standard (see below) <i>The diffused light is made by an opal acrylic under the glass - no optic inside.</i> |
| Finishes | Glass |
| Fixture Dimensions | Ø3.78" x 2.76" h |
| Fixture Weight | 1.32 lbs |
| LED Source | 1 COB LED High Density |
| Lumen Maintenance | L95,B10>50,000hrs (Ta 25°C) |
| Color Consistency | 2-Step MacAdam |
| Operating Temp. | -4°F to +113°F |
| IP Rating | IP67 |
| IK Rating | IK08 |
| Driveover | 2205 lbs |



Fixture Dimensions

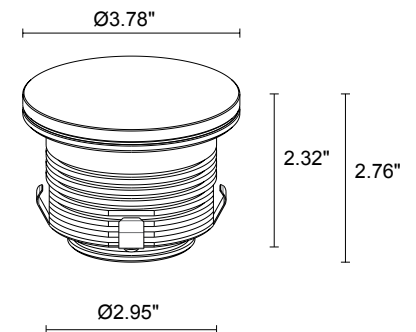

| Delivered Lumens (3000K, 38°) | 10W | 13W |
|-------------------------------|--------|---------|
| CRI 80 | 800 lm | 1065 lm |
| CRI 90 | 645 lm | 860 lm |

ORDERING INFORMATION

Example: LT54000FLNV or LT54000FLNV-3. Accessories / Power Supplies ordered separately.

| | | | | NV | |
|--------------|------------|-----------|------------------|------------|----------------|
| Model No. | CRI | CCT | Optics | Finish | Cable Length |
| LT5400 (10W) | 0 - 80 CRI | F - 2700K | S - 16° | NV - Glass | 4.92' standard |
| LT5401 (13W) | 1 - 90 CRI | 5 - 3000K | M - 21° | | 1 - 16.40' |
| | | 9 - 4000K | L - 38° | | 2 - 32.81' |
| | | | P - 48° sharp | | 3 - 49.21' |
| | | | K - 55° | | 4 - 65.62' |
| | | | W - 16°x69° adj. | | |
| | | | D - Diffuse | | |

Job Name/Date:

Fixture Type Designation:

SUGGESTED POWER SUPPLIES

24VDC

| Part Number | Description | Input/Output | # of Fixtures | |
|---------------------------|---|---|---------------|-----|
| | | | 10W | 13W |
| PPLT00056 | Non-Dim | 120-277VAC to 24VDC, 26W, Class 2, IP66 | 1-2 | 1-1 |
| PPLT00157 | Non-Dim | 120VAC to 24VDC, 60W, Class 2 | 1-4 | 1-3 |
| PPLT00599 | ELV / TRIAC & 0-10V Dimming (100 to 0%) | 120-277VAC to 24VDC, 96W, Class 2 | 1-7 | 1-5 |
| PPLT00158 | Non-Dim | 120VAC to 24VDC, 100W, Class 2 | 1-8 | 1-6 |
| PPLT00543 | 0-10V Dimming to 15% (-40°C / -40°F cold weather start) | 120-277VAC to 24VDC, 100W, Class 2 | 1-8 | 1-6 |

For other power supply options consult factory.

ACCESSORIES

Anti-Glare

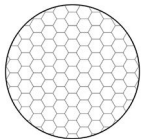

WH0204
Honeycomb louvre
Not available with diffuse (D), 48° sharp (P) and 16°x69° (W) optics

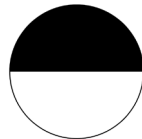

WE0604S
Anti-glare lens, half transparent and half serigraphed black

ACCESSORIES

Installation



WC4050
Outer Casing
For ingrade use



WL0500
Suction cup
REQUIRED for installation



WE0201
Magnet for use only with W- 16°x69° adjustable optic

Job Name/Date:

Fixture Type Designation:

PHOTOMETRIC DATA

Note all Photometry is CRI 80, 3000K

S - 16° CRI 80

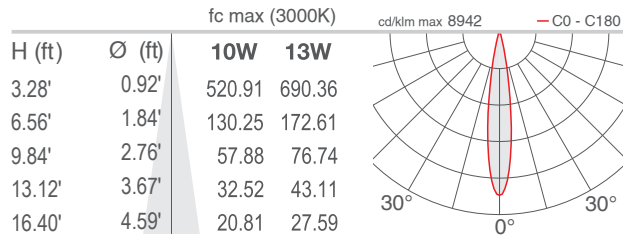

M - 21° CRI 80

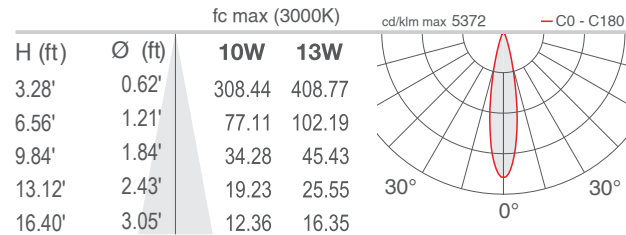

L - 38° CRI 80

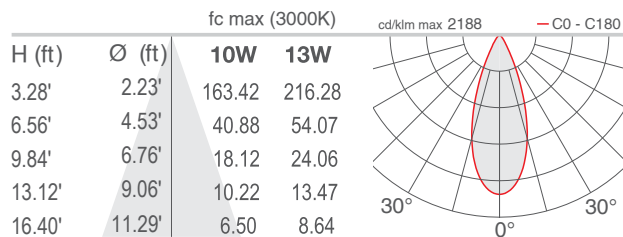

P - 48° sharp CRI 80

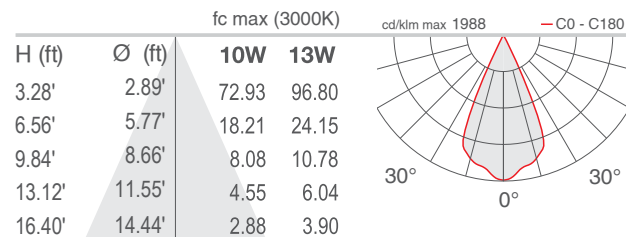

K - 55° CRI 80

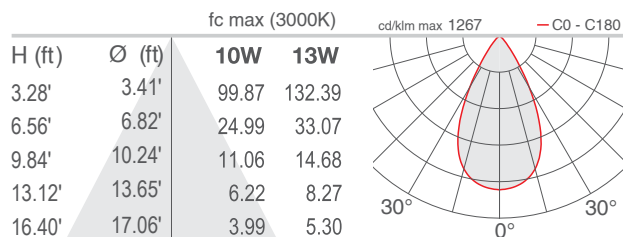

W - 16°x69° adjustable

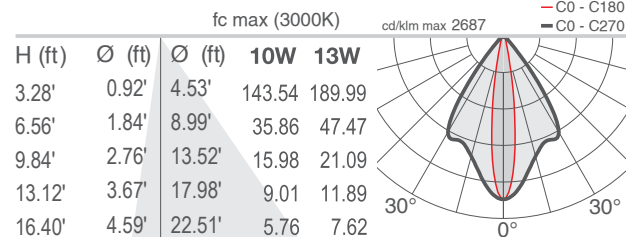

D - Diffuse CRI 80

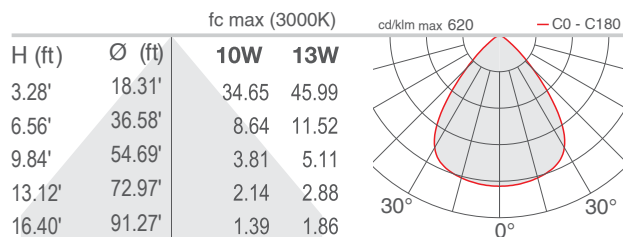

Job Name/Date:

Fixture Type Designation: