

LITUS 5.4

The Litus 5 series features a sophisticated flush/trimless mount design. With a wide selection of optic options, these fixtures are highly versatile for general and more dynamic lighting. The square version can be used for downlight applications as well. **The Bright 3, Smoothy 5 and Litus 5 series all use the same LED.**

TECHNICAL DATA

Wattage / Input	10W, 13W (24VDC)
Power Supply	Remote, not included. See page 2.
Construction	Body: Aluminum Alloy EN AW 6082 Lens: Tempered, Serigraphed-gray, and Transparent Extra-clear Glass
CCT	2700K, 3000K, 4000K
CRI	CRI >80, CRI >90
BUG Rating	B0-U3-G0 (3000K, 10W, P) B0-U4-G0 (3000K, 10W/13W, S, M, W, D) B0-U5-G0 (3000K, 13W, L, K)
Delivered Lumens	See chart - below right
Efficacy	80 lm/W (3000K, 10W, CRI 80) 65 lm/W (3000K, 10W, CRI 90) 82 lm/W (3000K, 13W, CRI 80) 66 lm/W (3000K, 13W, CRI 90)
Optics	7 Standard (see below) <i>The diffused light is made by an opal acrylic under the glass - no optic inside.</i>
Finishes	Glass
Fixture Dimensions	Ø3.78" x 2.76" h
Fixture Weight	1.32 lbs
LED Source	1 COB LED High Density
Lumen Maintenance	L95,B10>50,000hrs (Ta 25°C)
Color Consistency	2-Step MacAdam
Operating Temp.	-4°F to +113°F
IP Rating	IP67
IK Rating	IK08
Driveover	2205 lbs



Fixture Dimensions

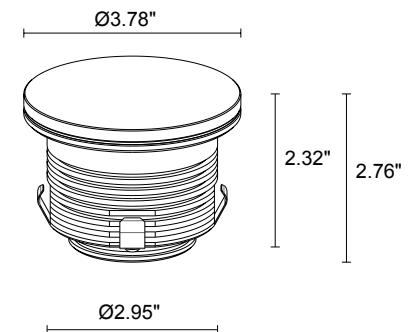

Delivered Lumens (3000K, 38°)	10W	13W
CRI 80	800 lm	1065 lm
CRI 90	645 lm	860 lm

ORDERING INFORMATION

Example: LT54000FLNV or LT54000FLNV-3. Accessories / Power Supplies ordered separately.

Model No.	CRI	CCT	Optics	Finish	Cable Length
LT5400 (10W)	0 - 80 CRI	F - 2700K	S - 16°	NV - Glass	4.92' standard
LT5401 (13W)	1 - 90 CRI	5 - 3000K 9 - 4000K	M - 21° L - 38° P - 48° sharp K - 55° W - 16°x69° adj. D - Diffuse		1 - 16.40' 2 - 32.81' 3 - 49.21' 4 - 65.62'

Job Name/Date:

Fixture Type Designation:

SUGGESTED POWER SUPPLIES

24VDC

Part Number	Description	Input/Output	# of Fixtures	
			10W	13W
PPLT00056	Non-Dim	120-277VAC to 24VDC, 26W, Class 2, IP66	1-2	1-1
PPLT00157	Non-Dim	120VAC to 24VDC, 60W, Class 2	1-4	1-3
PPLT00627	ELV / TRIAC & 0-10V Dimming (100 to 0%), I67	120-277VAC to 24VDC, 96W, Class 2	1-7	1-5
PPLT00158	Non-Dim	120VAC to 24VDC, 100W, Class 2	1-8	1-6
PPLT00543	0-10V Dimming to 15% (-40°C / -40°F cold weather start)	120-277VAC to 24VDC, 100W, Class 2	1-8	1-6

For other power supply options consult factory.

ACCESSORIES

Anti-Glare

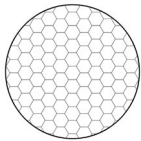

WH0204
Honeycomb louvre
Not available with diffuse (D), 48° sharp (P) and 16°x69° (W) optics

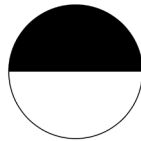

WE0604S
Anti-glare lens, half transparent and half serigraphed black

ACCESSORIES

Installation



WC4050
Outer Casing
For ingrade use



WL0500
Suction cup
REQUIRED for installation



WE0201
Magnet for use only with W- 16°x69° adjustable optic

Job Name/Date:

Fixture Type Designation:

PHOTOMETRIC DATA

Note all Photometry is CRI 80, 3000K

S - 16° CRI 80

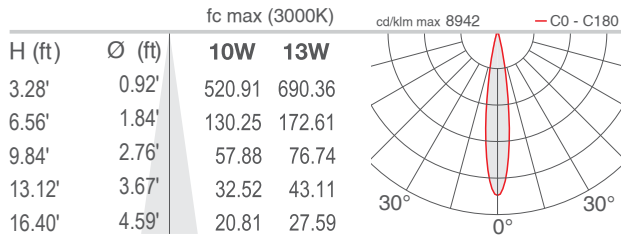

M - 21° CRI 80

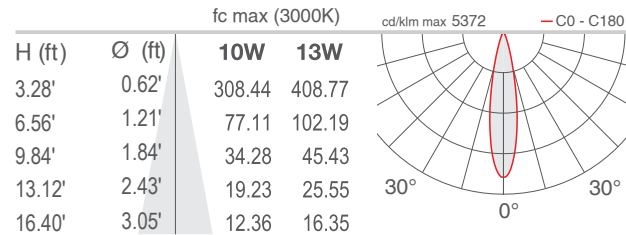

L - 38° CRI 80

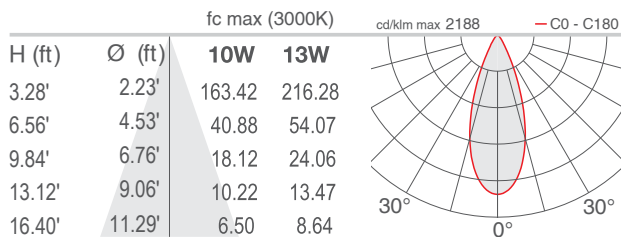

P - 48° sharp CRI 80

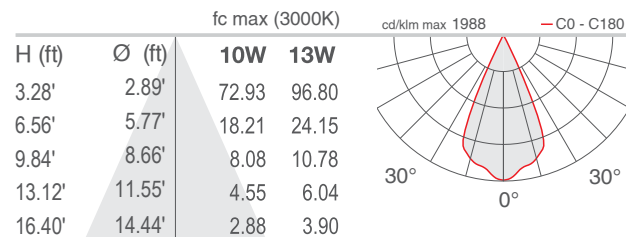

K - 55° CRI 80

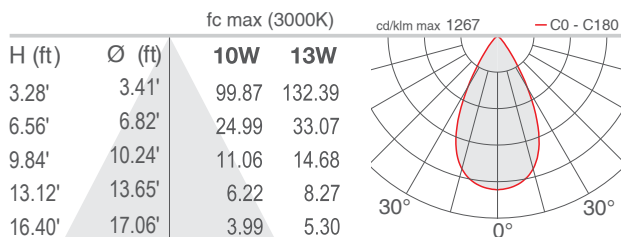

W - 16°x69° adjustable

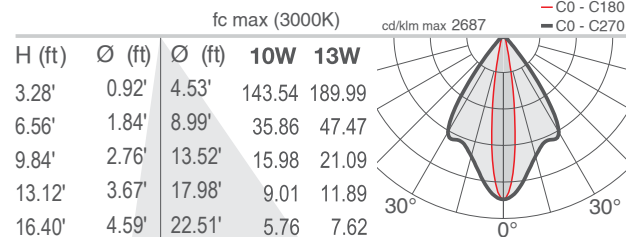

D - Diffuse CRI 80

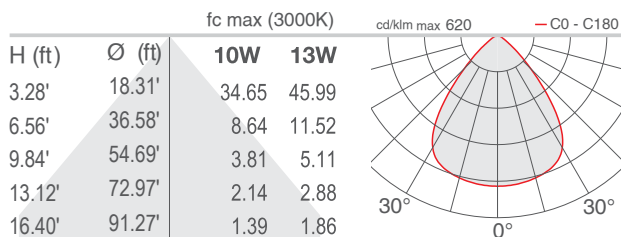

Job Name/Date:

Fixture Type Designation: