

# LITUS 5.4

The Litus 5 series features a sophisticated flush/trimless mount design. With a wide selection of optic options, these fixtures are highly versatile for general and more dynamic lighting. The square version can be used for downlight applications as well. **The Bright 3, Smoothy 5 and Litus 5 series all use the same LED.**



## TECHNICAL DATA

<b>Wattage / Input</b>	10W, 13W (24VDC)
<b>Power Supply</b>	Remote, not included. See page 2.
<b>Construction</b>	Body: Aluminum Alloy EN AW 6082 Lens: Tempered, Serigraphed-gray, and Transparent Extra-clear Glass
<b>CCT</b>	2700K, 3000K, 4000K
<b>CRI</b>	CRI >80, CRI >90
<b>BUG Rating</b>	B0-U3-G0 (3000K, 10W, P) B0-U4-G0 (3000K, 10W/13W, S, M, W, D) B0-U5-G0 (3000K, 13W, L, K)
<b>Delivered Lumens</b>	See chart - below right
<b>Efficacy</b>	80 lm/W (3000K, 10W, CRI 80) 65 lm/W (3000K, 10W, CRI 90) 82 lm/W (3000K, 13W, CRI 80) 66 lm/W (3000K, 13W, CRI 90)
<b>Optics</b>	7 Standard (see below) <i>The diffused light is made by an opal acrylic under the glass - no optic inside.</i>
<b>Finishes</b>	Glass
<b>Fixture Dimensions</b>	Ø3.78" x 2.76" h
<b>Fixture Weight</b>	1.32 lbs
<b>LED Source</b>	1 COB LED High Density
<b>Lumen Maintenance</b>	L95,B10>50,000hrs (Ta 25°C)
<b>Color Consistency</b>	2-Step MacAdam
<b>Operating Temp.</b>	-4°F to +113°F
<b>IP Rating</b>	IP67
<b>IK Rating</b>	IK08
<b>Driveover</b>	2205 lbs

Fixture Dimensions

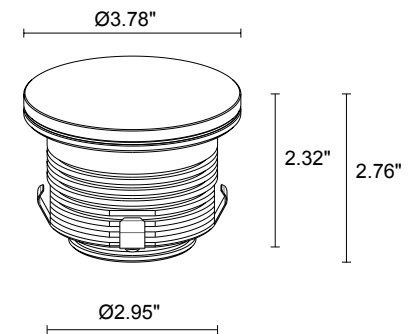

Delivered Lumens (3000K, 38°)	10W	13W
<b>CRI 80</b>	800 lm	1065 lm
<b>CRI 90</b>	645 lm	860 lm

## ORDERING INFORMATION

Example: LT54000FLNV or LT54000FLNV-3. Accessories / Power Supplies ordered separately.

Model No.	CRI	CCT	Optics	Finish	Cable Length
LT5400 (10W)	0 - 80 CRI	F - 2700K	S - 16°	NV - Glass	4.92' standard
LT5401 (13W)	1 - 90 CRI	5 - 3000K 9 - 4000K	M - 21° L - 38° P - 48° sharp K - 55° W - 16°x69° adj. D - Diffuse		1 - 16.40' 2 - 32.81' 3 - 49.21' 4 - 65.62'

Job Name/Date:

Fixture Type Designation:

## SUGGESTED POWER SUPPLIES

24VDC

Part Number	Description	Input/Output	# of Fixtures	
			10W	13W
<a href="#">PPLT00586</a>	Non-Dim	120-277VAC to 24VDC, 40W, Class 2	1-3	1-2
<a href="#">PPLT00709</a>	ELV / TRIAC & 0-10V Dimming	120-277VAC to 24VDC, 96W, Class 2, DAMP	1-7	1-5
<a href="#">PPLT00543</a>	0-10V Dimming to 15% (-40°C / -40°F cold weather start)	120-277VAC to 24VDC, 100W, Class 2	1-8	1-6

## Suggested Lutron Compatible

Part Number	Option	Lutron SKU	Dim Range	Description	Input/Output	# of Fixtures	
						10W	13W
<a href="#">PPLT00273</a>	L3DAE / L3DA3W	L3DA	100%-1%	Hi-Lume™ 1% EcoSystem™ or 1% 3-Wire LED Driver	120-277VAC to 24VDC, 40W, Class 2	1-3	1-2
<a href="#">PPLT00530</a>	L3DAE / L3D0	L3DA/L3D0	100%-1%	Hi-Lume™ 0.1% EcoSystem™ or 3-Wire LED Driver	120-277VAC to 24VDC, 96W, Class 2	1-7	1-5

For other power supply options consult factory.

## ACCESSORIES

### Anti-Glare

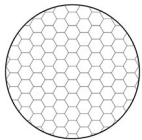

**WH0204**  
Honeycomb louvre  
Not available with diffuse (D), 48° sharp (P) and 16°x69° (W) optics

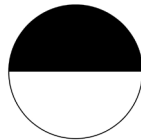

**WE0604S**  
Anti-glare lens, half transparent and half serigraphed black

## ACCESSORIES

### Installation



**WC4050**  
Outer Casing  
For ingrade use



**WL0500**  
Suction cup  
**REQUIRED for installation**



**WE0201**  
Magnet for use only with W- 16°x69° adjustable optic

Job Name/Date:

Fixture Type Designation:

## PHOTOMETRIC DATA

Note all Photometry is CRI 80, 3000K

### S - 16° CRI 80

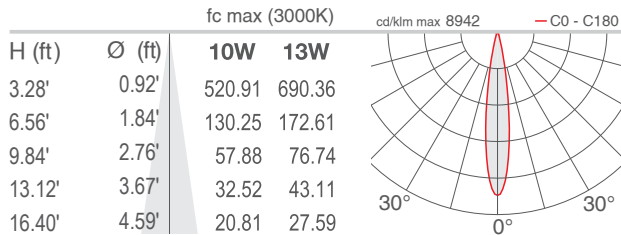

### M - 21° CRI 80

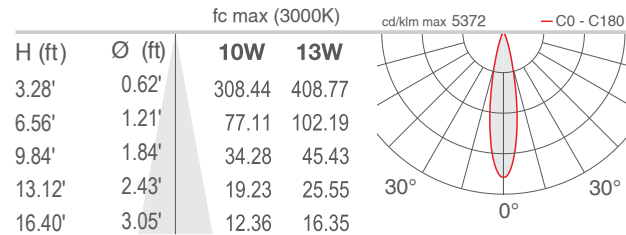

### L - 38° CRI 80

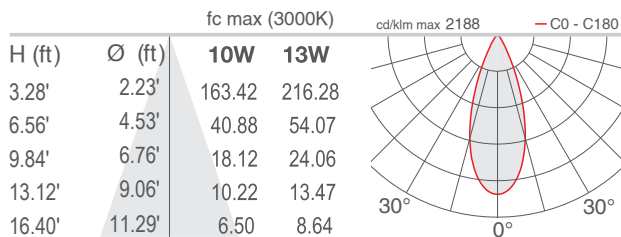

### P - 48° sharp CRI 80

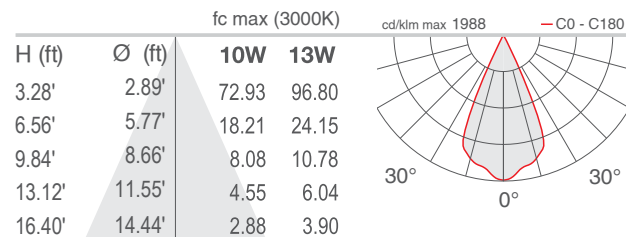

### K - 55° CRI 80

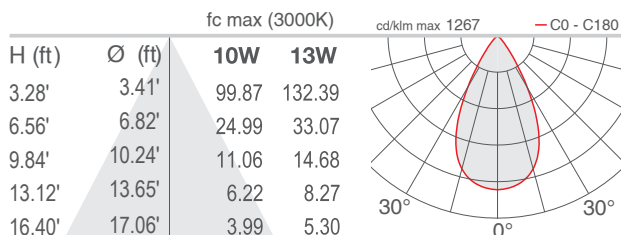

### W - 16°x69° adjustable

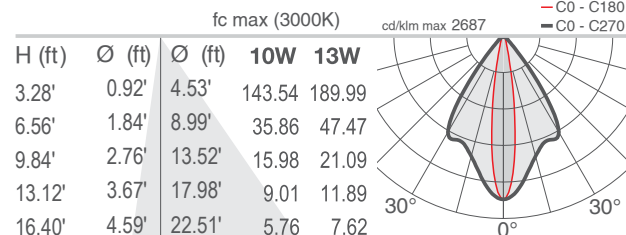

### D - Diffuse CRI 80

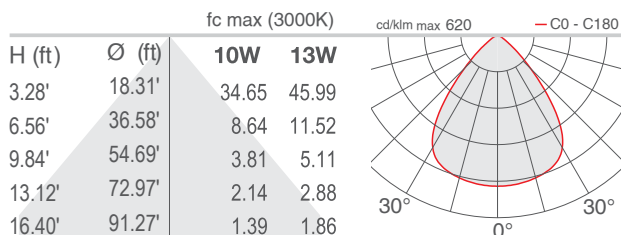

Job Name/Date:

Fixture Type Designation: