

The Litus 5 series features a sophisticated flush/trimless mount design. With a wide selection of optic options, these fixtures are highly versatile for general and more dynamic lighting. The square version can be used for downlight applications as well. **The Bright 3, Smoothy 5 and Litus 5 series all use the same LED.**

## TECHNICAL DATA

<b>Wattage / Input</b>	10W, 13W (24VDC)
<b>Power Supply</b>	Remote, not included. See page 2.
<b>Construction</b>	Body: Aluminum alloy EN AW 6082 Lens: Tempered, serigraphed-gray, and transparent extra-clear glass
<b>CCT</b>	2700K, 3000K, 4000K
<b>CRI</b>	CRI >80, CRI >90
<b>Delivered Lumens</b>	See chart - below right
<b>Efficacy</b>	80 lm/W (3000K, 10W, CRI 80) 65 lm/W (3000K, 10W, CRI 90) 82 lm/W (3000K, 13W, CRI 80) 66 lm/W (3000K, 13W, CRI 90)
<b>Optics</b>	7 Standard (see below) <i>The diffused light is made by an opal acrylic under the glass - no optic inside.</i>
<b>Finishes</b>	Glass
<b>Fixture Dimensions</b>	3.74" w x 3.74" h
<b>Fixture Weight</b>	1.32 lbs
<b>LED Source</b>	1 COB LED High Density
<b>Lumen Maintenance</b>	L95,B10>50,000hrs (Ta 25°C)
<b>Color Consistency</b>	2-Step MacAdam
<b>Operating Temp.</b>	-4°F to +113°F
<b>IP Rating</b>	IP67
<b>IK Rating</b>	IK08
<b>Driveover</b>	2205 lbs



Fixture Dimensions

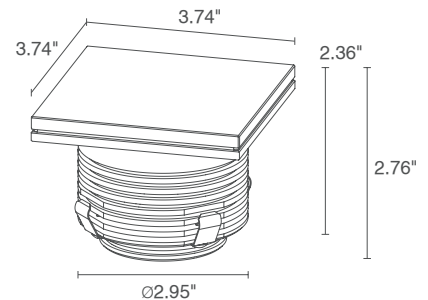

Delivered Lumens (3000K, 38°)	10W	13W
<b>CRI 80</b>	800 lm	1065 lm
<b>CRI 90</b>	645 lm	860 lm

## ORDERING INFORMATION

Example: **LT55000FLNV** or **LT55000FLNV-1**. Accessories / Power Supplies ordered separately.

				<b>NV</b>	
Model No.	CRI	CCT	Optics	Finish	Cable Length
<b>LT5500</b> (10W)	<b>0</b> - 80 CRI	<b>F</b> - 2700K	<b>S</b> - 16°	<b>NV</b> - Glass	4.92' standard
<b>LT5501</b> (13W)	<b>1</b> - 90 CRI	<b>5</b> - 3000K	<b>M</b> - 21°		<b>1</b> - 16.40'
		<b>9</b> - 4000K	<b>L</b> - 38°		<b>2</b> - 32.81'
			<b>P</b> - 48° sharp		<b>3</b> - 49.21'
			<b>K</b> - 55°		<b>4</b> - 65.62'
			<b>W</b> - 16°x69° adj.		
			<b>D</b> - Diffuse		

Job Name/Date:

Fixture Type Designation:

## SUGGESTED POWER SUPPLIES

24VDC

Part Number	Description	Input/Output	# of Fixtures 10W / 13W	
<a href="#">PPLT00056</a>	Non-Dim	120-277VAC to 24VDC, 26W, Class 2, IP66	1-2	1-1
<a href="#">PPLT00157</a>	Non-Dim	120VAC to 24VDC, 60W, Class 2	1-4	1-3
<a href="#">PPLT00599</a>	ELV / TRIAC & 0-10V Dimming (100 to 0%)	120-277VAC to 24VDC, 96W, Class 2	1-7	1-5
<a href="#">PPLT00158</a>	Non-Dim	120VAC to 24VDC, 100W, Class 2	1-8	1-6
<a href="#">PPLT00543</a>	0-10V Dimming to 15% (-40°C / -40°F cold weather start)	120-277VAC to 24VDC, 100W, Class 2	1-8	1-6

For other power supply options consult factory.

## ACCESSORIES

### Anti-Glare

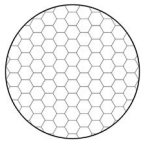

**WH0204**  
Honeycomb louvre  
*Not available with diffuse (D), 48° sharp (P) and 16°x69° (W) optics*



**WE0605S**  
Anti-glare lens, half transparent and half serigraphed black

## ACCESSORIES

### Installation

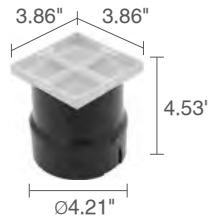

**WC4051**  
Outer Casing  
*For in-grade use*



**WL0500**  
Suction cup  
**REQUIRED for installation**

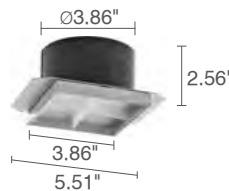

**WC4551**  
Outer Casing  
*For plasterboard/ceiling use*



**WE0201**  
Magnet for use only with W- 16°x69° adjustable optic

Job Name/Date:

Fixture Type Designation:

## PHOTOMETRIC DATA

Note all Photometry is CRI 80, 3000K

### S - 16° CRI 80

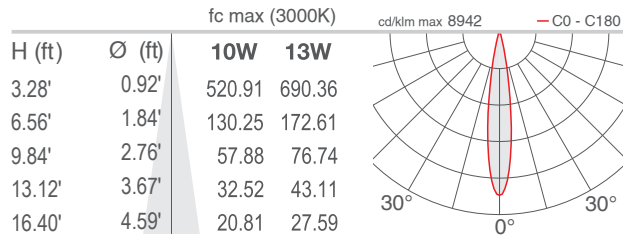

### M - 21° CRI 80

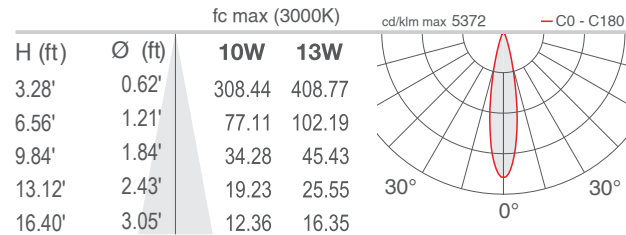

### L - 38° CRI 80

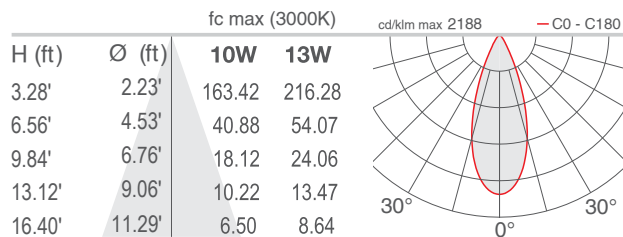

### P - 48° sharp CRI 80

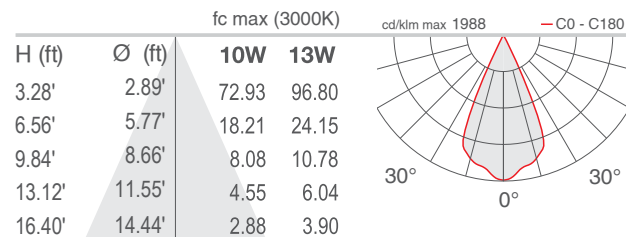

### K - 55° CRI 80

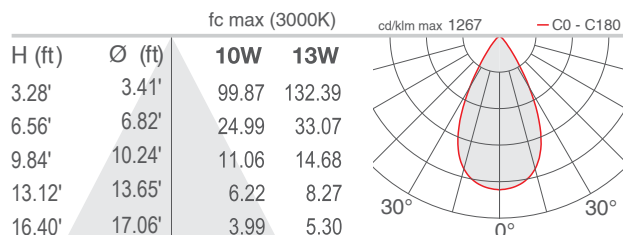

### W - 16°x69° adjustable

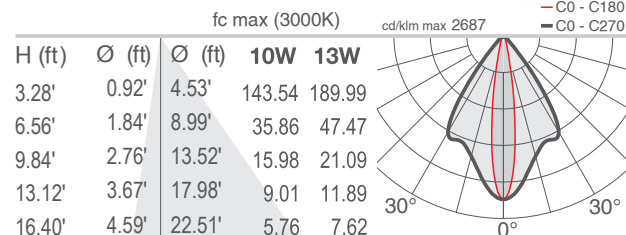

### D - Diffuse CRI 80

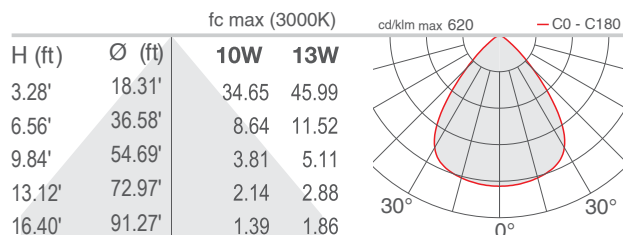

Job Name/Date:

Fixture Type Designation: