

# LITUS 5.5

The Litus 5 series features a sophisticated flush/trimless mount design. With a wide selection of optic options, these fixtures are highly versatile for general and more dynamic lighting. The square version can be used for downlight applications as well. **The Bright 3, Smoothy 5 and Litus 5 series all use the same LED.**

## TECHNICAL DATA

<b>Wattage / Input</b>	10W, 13W (24VDC)
<b>Power Supply</b>	Remote, not included. See page 2.
<b>Construction</b>	Body: Aluminum alloy EN AW 6082 Lens: Tempered, serigraphed-gray, and transparent extra-clear glass
<b>CCT</b>	2700K, 3000K, 4000K
<b>CRI</b>	CRI >80, CRI >90
<b>BUG Rating</b>	B0-U3-G0 (3000K, 10W, P) B0-U4-G0 (3000K, 10W/13W, S, M, W, D) B0-U5-G0 (3000K, 13W, L, K)
<b>Delivered Lumens</b>	See chart - below right
<b>Efficacy</b>	80 lm/W (3000K, 10W, CRI 80) 65 lm/W (3000K, 10W, CRI 90) 82 lm/W (3000K, 13W, CRI 80) 66 lm/W (3000K, 13W, CRI 90)
<b>Optics</b>	7 Standard (see below) <i>The diffused light is made by an opal acrylic under the glass - no optic inside.</i>
<b>Finishes</b>	Glass
<b>Fixture Dimensions</b>	3.74" w x 3.74" h
<b>Fixture Weight</b>	1.32 lbs
<b>LED Source</b>	1 COB LED High Density
<b>Lumen Maintenance</b>	L95,B10>50,000hrs (Ta 25°C)
<b>Color Consistency</b>	2-Step MacAdam
<b>Operating Temp.</b>	-4°F to +113°F
<b>IP Rating</b>	IP67
<b>IK Rating</b>	IK08
<b>Driveover</b>	2205 lbs



Fixture Dimensions

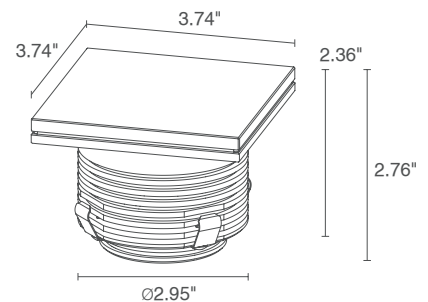

Delivered Lumens (3000K, 38°)	10W	13W
<b>CRI 80</b>	800 lm	1065 lm
<b>CRI 90</b>	645 lm	860 lm

## ORDERING INFORMATION

Example: LT5500FLNV or LT5500FLNV-1. Accessories / Power Supplies ordered separately.

Model No.	CRI	CCT	Optics	Finish	Cable Length
LT5500 (10W)	0 - 80 CRI	F - 2700K	S - 16°	NV - Glass	4.92' standard
LT5501 (13W)	1 - 90 CRI	5 - 3000K	M - 21°		1 - 16.40'
		9 - 4000K	L - 38°		2 - 32.81'
			P - 48° sharp		3 - 49.21'
			K - 55°		4 - 65.62'
			W - 16°x69° adj.		
			D - Diffuse		

Job Name/Date:

Fixture Type Designation:

## SUGGESTED POWER SUPPLIES

24VDC

Part Number	Description	Input/Output	# of Fixtures	
			10W	13W
<a href="#">PPLT00586</a>	Non-Dim	120-277VAC to 24VDC, 40W, Class 2	1-3	1-2
<a href="#">PPLT00709</a>	ELV / TRIAC & 0-10V Dimming	120-277VAC to 24VDC, 96W, Class 2, DAMP	1-7	1-5
<a href="#">PPLT00543</a>	0-10V Dimming to 15% (-40°C / -40°F cold weather start)	120-277VAC to 24VDC, 100W, Class 2	1-8	1-6

## Suggested Lutron Compatible

Part Number	Option	Lutron SKU	Dim Range	Description	Input/Output	# of Fixtures	
						10W	13W
<a href="#">PPLT00273</a>	L3DAE / L3DA3W	L3DA	100%-1%	Hi-Lume™ 1% EcoSystem™ or 1% 3-Wire LED Driver	120-277VAC to 24VDC, 40W, Class 2	1-3	1-2
<a href="#">PPLT00530</a>	L3DAE / L3D0	L3DA/L3D0	100%-1%	Hi-Lume™ 0.1% EcoSystem™ or 3-Wire LED Driver	120-277VAC to 24VDC, 96W, Class 2	1-7	1-5

For other power supply options consult factory.

## ACCESSORIES

### Anti-Glare

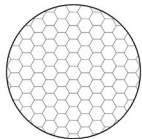

#### WH0204

Honeycomb louvre  
*Not available with diffuse (D), 48° sharp (P) and 16°x69° (W) optics*



#### WE0605S

Anti-glare lens, half transparent and half serigraphed black

## ACCESSORIES

### Installation

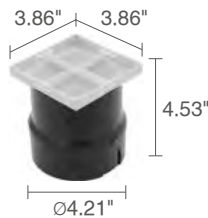

#### WC4051

Outer Casing  
*For ingrade use*



#### WL0500

Suction cup  
**REQUIRED for installation**

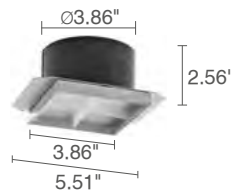

#### WC4551

Outer Casing  
*For plasterboard/ceiling use*



#### WE0201

Magnet for use only with  
W- 16°x69° adjustable optic

Job Name/Date:

Fixture Type Designation:

## PHOTOMETRIC DATA

Note all Photometry is CRI 80, 3000K

### S - 16° CRI 80

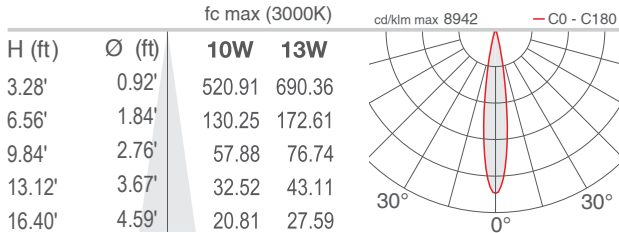

### M - 21° CRI 80

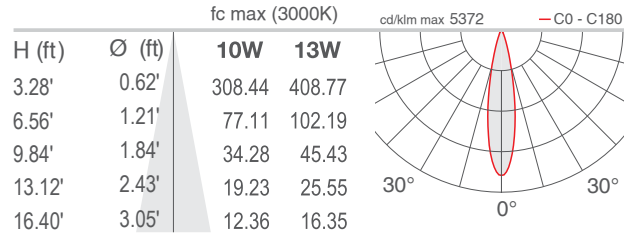

### L - 38° CRI 80

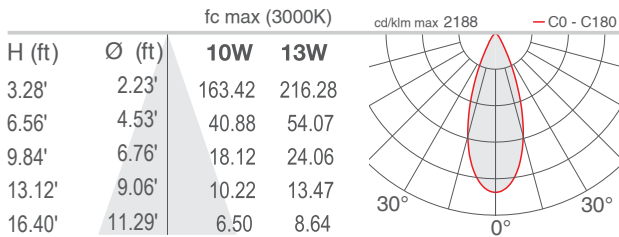

### P - 48° sharp CRI 80

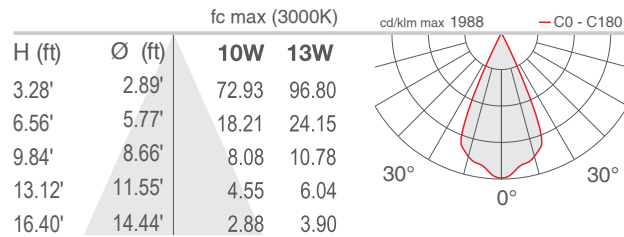

### K - 55° CRI 80

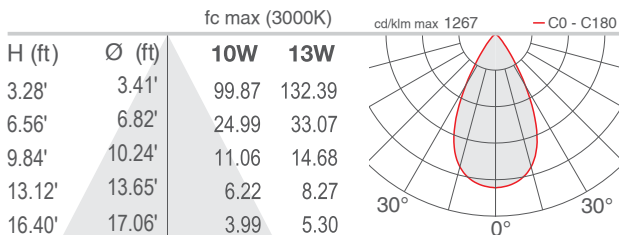

### W - 16°x69° adjustable

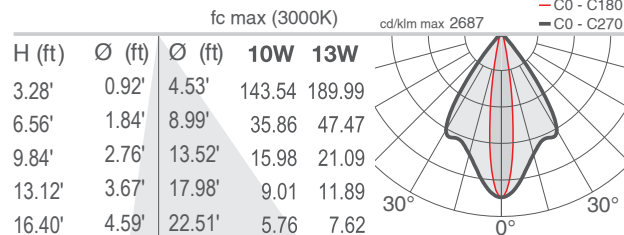

### D - Diffuse CRI 80

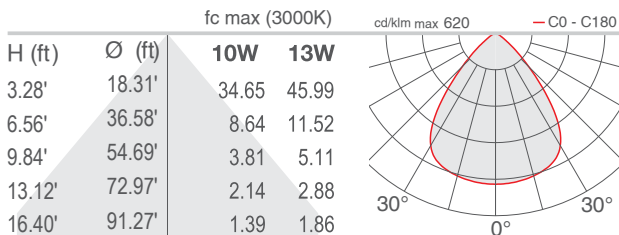

Job Name/Date:

Fixture Type Designation: