

# LITUS 5.7

The Litus 5 series features a sophisticated flush/trimless mount design. With a wide selection of optic options these fixtures are highly versatile for both general and more dynamic lighting. The square version can be used for downlight applications as well. **The Bright 3, Smoothy 5 and Litus 5 series all use the same LED.**



## TECHNICAL DATA

<b>Wattage / Input</b>	3.5W, 5W, 7W (24VDC); 7W RGB (700mA)
<b>Power Supply</b>	Remote, not included. See page 2
<b>Construction</b>	Body: Aluminum Alloy EN AW 6082 Lens: Tempered, Serigraphed-gray, and Transparent Extra-clear Glass
<b>CCT</b>	2700K, 3000K, 4000K, RGB
<b>CRI</b>	CRI >80, CRI >90
<b>BUG Rating</b>	B0-U3-G0 (3000K, all versions)
<b>Delivered Lumens</b>	See chart - below right for static white RGB: 235 lm: (R) 92 lm, (G) 105 lm, (B) 38 lm
<b>Efficacy</b>	70.4 lm/W (34°, 5W), 56.8 lm/W (34°, 5W) 66.1 lm/W (34°, 7W), 53.4 lm/W (34°, 7W) 33.6 lm/W (RGB)
<b>Optics</b>	9 Standard (white), 4 Standard (RGB) <i>The diffused light is made by an opal acrylic under the glass - no optic inside.</i>
<b>Finishes</b>	Glass
<b>Fixture Dimensions</b>	3.79" w x 3.79" h
<b>Fixture Weight</b>	1.54 lbs
<b>LED Source</b>	1 High Intensity Power LED; RGB: 3 Power LEDs
<b>Lumen Maintenance</b>	L90,B10>50,000hrs (Ta 25°C)
<b>Color Consistency</b>	3-Step MacAdam (white LED color)
<b>Operating Temp.</b>	-4°F to +113°F
<b>IP Rating</b>	IP67
<b>IK Rating</b>	IK08
<b>Driveover</b>	2205 lbs

Fixture Dimensions

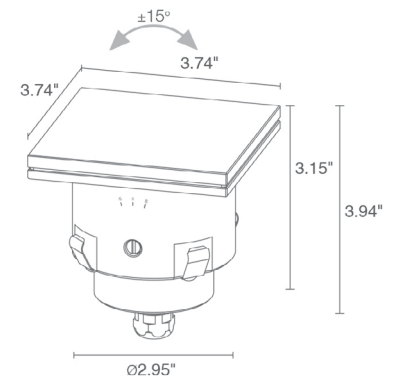

Delivered Lumens (3000K)	5W 34°	7W 34°
<b>CRI 80</b>	352 lm	463 lm
<b>CRI 90</b>	284 lm	374 lm

## ORDERING INFORMATION

Example: LT57010FLNV or LT57010FLNV-2. Accessories / Power Supplies ordered separately.

Model #	Wattage	CRI	CCT	Optics - tiltable ±15°	Finish	Cable Length
LT570	0 - 3.5W only 5° optics	0 - 80 CRI	F - 2700K	U - 5° only 3.5W    M - 34°	NV - Glass	0 - 4.92' standard
	1 - 5W	1 - 90 CRI	5 - 3000K	V - 8°                    L - 45°		1 - 16.40'
	2 - 7W		9 - 4000K	T - 11°                  Q - 61° sharp		2 - 32.81'
LT5732			6 - RGB	S - 17°                  W - 13°x52°	NV - Glass	3 - 49.21'
				P - 21° sharp		4 - 65.62'
				Optics - tiltable ±15°		
				S - 20°                  L - 45°		
				M - 34°                  W - 21°x42°		

Job Name/Date:

Fixture Type Designation:

## SUGGESTED POWER SUPPLIES

24VDC

Part Number	Description	Input/Output	# of Fixtures		
			3.5W	5W	7W
<a href="#">PPLT00056</a>	Non-Dim	120-277VAC to 24VDC, 26W, Class 2, IP66	1-5	1-4	1-2
<a href="#">PPLT00157</a>	Non-Dim	120VAC to 24VDC, 60W, Class 2	1-13	1-9	1-6
<a href="#">PPLT00627</a>	ELV / TRIAC & 0-10V Dimming (100 to 0%), IP67	120-277VAC to 24VDC, 96W, Class 2	1-21	1-15	1-10
<a href="#">PPLT00158</a>	Non-Dim	120VAC to 24VDC, 100W, Class 2	1-22	1-16	1-11
<a href="#">PPLT00543</a>	0-10V Dimming to 15% (-40°C / -40°F cold weather start)	120-277VAC to 24VDC, 100W, Class 2	3-22	2-16	2-11

700mA - RGB

Part Number	Description	Input/Output	# of Fixtures 7W
<a href="#">PPLT00244-P</a>	DMX / RDM (Must advise DMX addresses if not using RDM)	120-277VAC to 700mA, 50W, Class 2	1-5
<a href="#">PPLT00129-P</a>	DMX / RDM (Field Addressable)	120-277VAC to 700mA, 100W, Class 2	1-9

For other power supply options consult factory.

## ACCESSORIES

### Anti-Glare

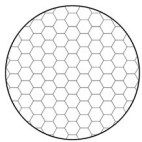

#### WH0205

Honeycomb Louvre  
*Not available for sharp optics (P, Q) and on 5° (U) and 8° (V) optics on request.*



#### WE0605S

Anti-glare lens, half transparent and half serigraphed black  
*Can be fitted on all optics except for RGB version*

## ACCESSORIES

### Installation

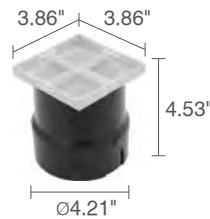

#### WC4051

Outer Casing  
*For ingrade use*



#### WL0500

Suction cup  
**REQUIRED for installation**

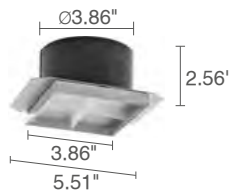

#### WC4551

Outer Casing  
*For plasterboard/ceiling use*

Job Name/Date:

Fixture Type Designation:

## PHOTOMETRIC DATA

Note all Photometry is CRI 80, 3000K

### U - 5° CRI 80

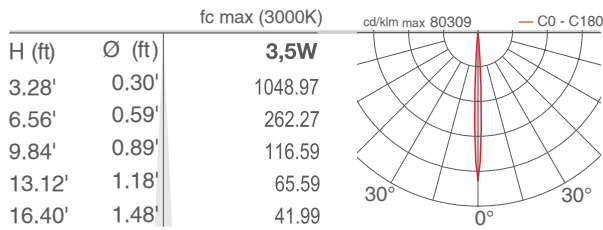

### V - 8° CRI 80

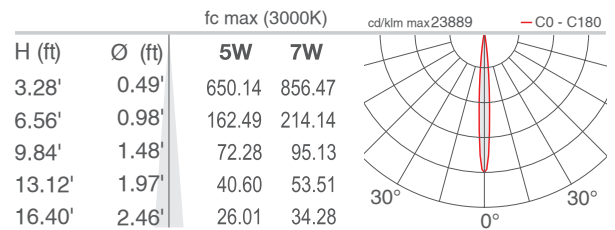

### T - 11° CRI 80

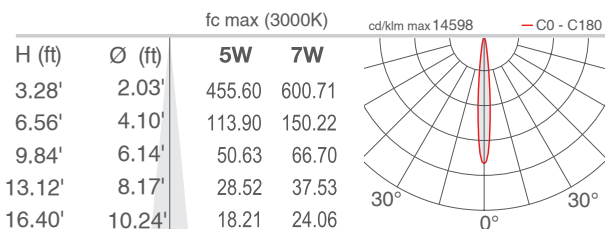

### S - 17° CRI 80

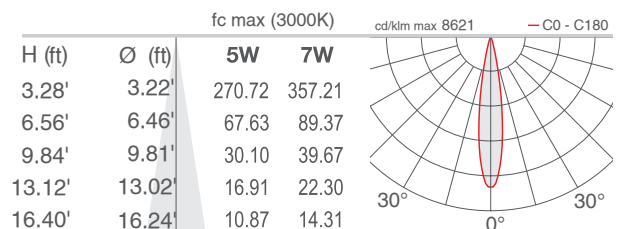

### P - 21° sharp CRI 80

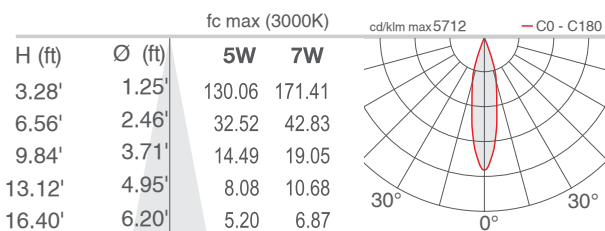

### M - 34° CRI 80

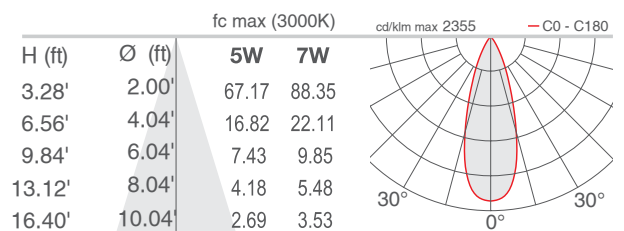

### L - 45° CRI 80

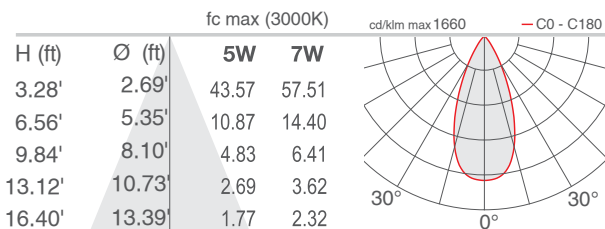

### Q - 61° sharp CRI 80

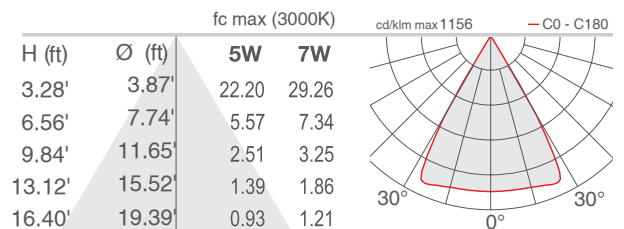

### W - 13°x52° CRI 80

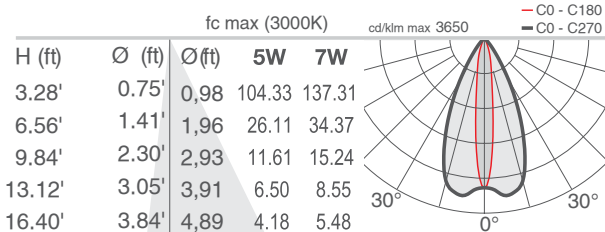

### D - Diffuse CRI 80 (Litus 2.4 / 2.5)

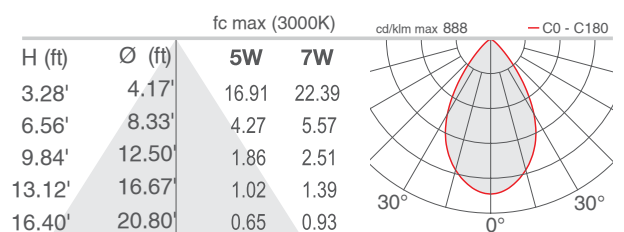

Job Name/Date:

Fixture Type Designation: