

PIVOT 2.0

Pivot 2.0 is a compact outdoor projector that can be surface mounted on ceilings, walls or floors. It is available in 4 different optics and is adjustable 360° on the horizontal axis and +/- 90° on the vertical axis with a manual zoom lens adjustable using a magnet.



TECHNICAL DATA

Wattage / Input	10W, 14W (24VDC)
Power Supply	Remote, not included. See page 2.
Construction	Body: Anti-corrosive Aluminum Alloy EN AW 6082 Lens: Tempered Extra-clear Glass Neoprene Cable: 4.9' standard
CCT	2700K, 3000K, 4000K (3500K available, consult factory)
CRI	80, >90
Delivered Lumens	1064 lm (3000K, 25°, 14W, CRI 80) 676 lm (3000K, 25°, 10W, CRI 90) 862 lm (3000K, 25°, 14W, CRI 90) 835 lm (3000K, 25°, 10W, CRI 80)
Efficacy	76 lm/W (14W, CRI 80), 67.6 lm/W (10W, CRI 90) 61.6 lm/W (14W, CRI 90), 83.5 lm/W (10W, CRI 80)
Optics	6 Standard (see below)
Finishes	4 Standard, Custom RAL (see below)
Fixture Dimensions	Ø2.36" x 3.78", Ø2.36" Base
Fixture Weight	1.41 lbs
LED Source	1 COB LED
Lumen Maintenance	L95, B10>50,000hrs (Ta 25°C)
Color Consistency	3-Step MacAdam
Operating Temp.	-4°F to +113°F
IP Rating	IP66
Impact Rating	IK08

Fixture Dimensions

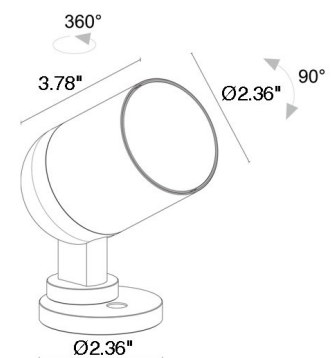

 **Magnet required with adjustable optic**
(see part number - page 2)

ORDERING INFORMATION

Example: CP2001000090MH or CP2001000090MH-3. Accessories / Power Supplies ordered separately.

Model #	Wattage	CRI	Optical Access.	CCT	Optics	Finish	Cable Length
CP200	0 - 10W 1 - 14W	0 - CRI 80 1 - CRI 90	000 - none 001 - Honeycomb Louvre <i>*honeycomb louvre not available with 50° sharp, 13°x68° optics and optical range 15°-43° optics</i>	F - 2700K 5 - 3000K 9 - 4000K	0S - 13° 0M - 25° 0L - 37° 0Q - 50° sharp 0W - 13°x68° adjustable R3 - 15°-43° range	E - White H - Anthracite T - Cor-ten U - Copper C - Custom RAL (consult factory for "C")	4.92' standard 1 - 16.40' 2 - 32.81' 3 - 49.21' 4 - 65.62'

Job Name/Date:

Fixture Type Designation:

SUGGESTED POWER SUPPLIES 24VDC

Part Number	Description	Input/Output	# of Fixtures	
			10W	14W
PPLT00481	Non-Dim	120-277VAC to 24VDC, 24W, Class 2	1-1	1-1
PPLT00056	Non-Dim	120-277VAC to 24VDC, 26W, Class 2, IP66	1-2	1-1
PPLT00157	Non-Dim	120VAC to 24VDC, 60W, Class 2	1-4	1-3
PPLT00284	Non-Dim	120-277VAC to 24VDC, 100W, Class 2	1-8	1-5
PPLT00543	0-10V Dimming to 15% (-40°C / -40°F cold weather start)	120-277VAC to 24VDC, 100W, Class 2	1-8	1-5

For other power supply options consult factory.

ACCESSORIES - Anti-Glare

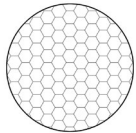

Honeycomb Louvre
built into the lighting fixture -
see code matrix above

Can be fitted on all
optics, except for 50° sharp,
13°x68° optics and optical
range 15°—43°



WB1001__
Standard Snoot
For Snoots include one of the below finishes:
E - White
H - Anthracite
T - Cor-ten
U - Copper
C - Custom RAL



WB1002__
Asymmetric Snoot

Installation

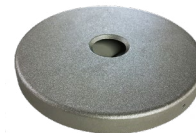

AC-0003__
Mounting Canopy for "J" Box
For Canopy include one of the below finishes:
E - White
H - Anthracite
T - Cor-ten
U - Copper
C - Custom RAL



OPTICS

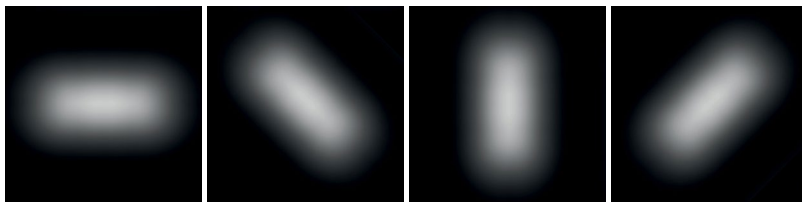

13°x68° - adjustable using the magnet

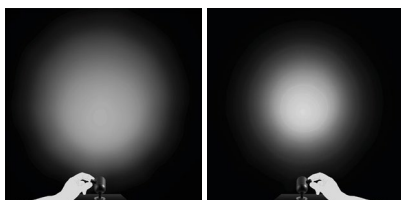

Manual Zoom - adjustable using the magnet

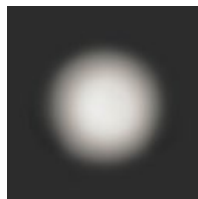

Fixed

ACCESSORIES - Optical



WE0201
Magnet for adjustable optics

Job Name/Date:

Fixture Type Designation:

PHOTOMETRIC DATA

Note all Photometry is 3000K, CRI 80

13° 10W

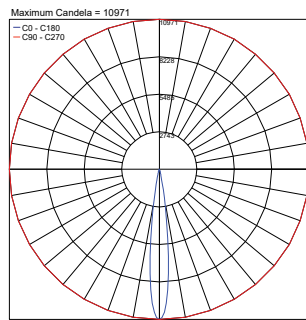

13° 14W

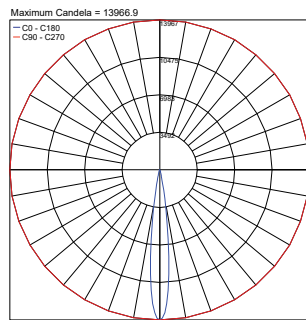

25° 10W

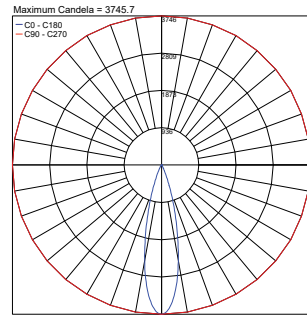

25° 14W

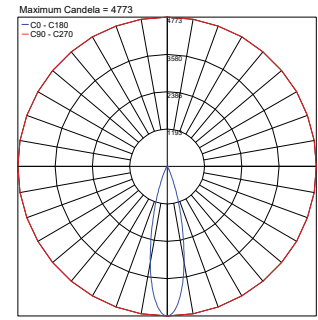

37° 10W

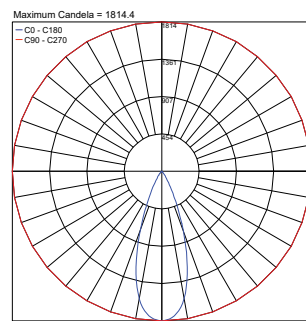

37° 14W

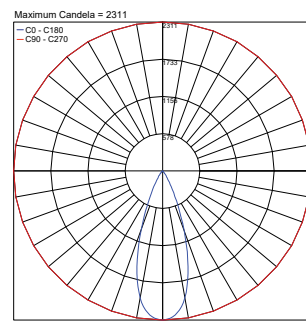

50° sharp 10W

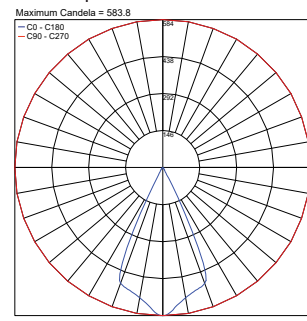

50° sharp 14W

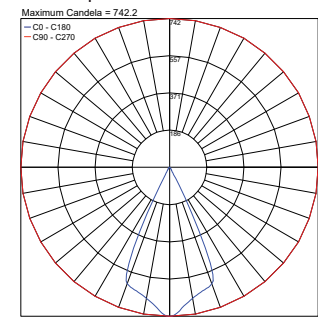

Adjustable 13°x68° 10W

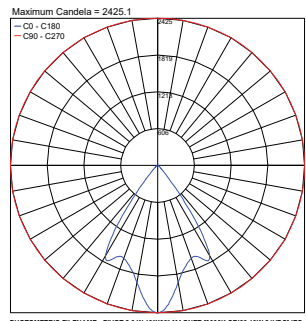

Adjustable 13°x68° 14W

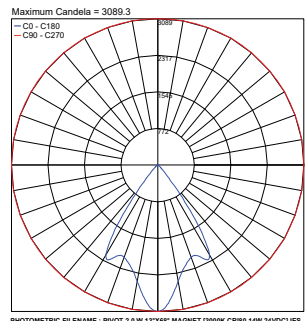

R3 zoom 15° 10W

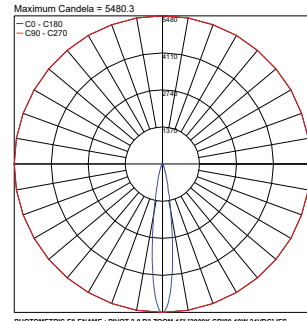

R3 zoom 15° 14W

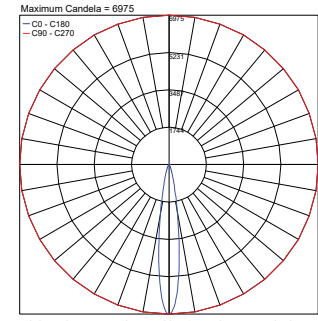

R3 zoom 43° 10W

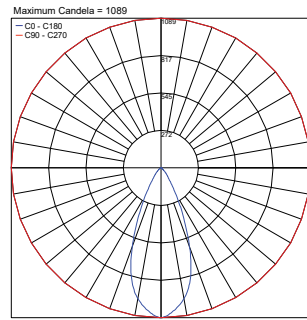

R3 zoom 43° 14W

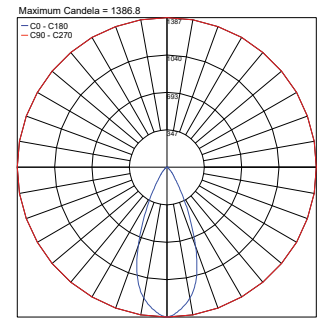

Job Name/Date:

Fixture Type Designation: