

# Q4 48V

Q4 48V is an high performance projector for the 48V track system with minimal visual impact and is 360° completely adjustable. It is available in 3 different optics and 6 standard finishes, including anodized rose gold, and champagne. The Q4 48V projector has an LED (COB) CRI >90, 3000K (2700K light source on request).



## TECHNICAL DATA

<b>Wattage / Input</b>	9W
<b>Track Power Supply</b>	Remote 48VDC power supply for track, not included. See 48V Track datasheet
<b>Track Head</b>	Integral 48V LED Converter in Track Adapter
<b>Dimming</b>	Non-Dim, 0-10V Dim, Dali
<b>Construction</b>	Body: Aluminum
<b>CCT</b>	3000K (2700K on request)
<b>CRI</b>	>90
<b>Delivered Lumens</b>	850 lm (3000K)
<b>Efficacy</b>	94.4 lm/W (3000K)
<b>Optics</b>	35° standard (14°, 55° on request)
<b>Finishes</b>	6 Standard, See Below
<b>Fixture Dimensions</b>	Head: Ø2.2" x 5.1" Base: 0.8" x 6.5"
<b>Fixture Weight</b>	1.10 lbs
<b>IP Rating</b>	IP40

Fixture Dimensions

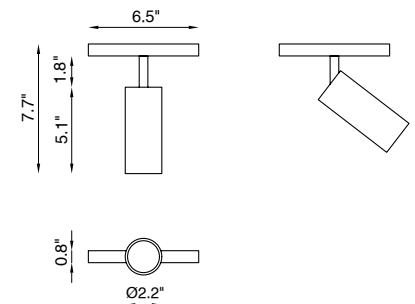

## ORDERING INFORMATION

Example: *BUT048 L 00008.A1.35.30.ND.0.US*. Track ordered separately.

BUT048 L 00008					0	US
Model No.	Finish	Optic	CCT	Dimmability		
BUT048 L 00008	W1 - White B1 - Black CP - Chrome BR - Brass A1 - Champagne A2 - Rose Gold	14 - 14° 35 - 35° 55 - 55°	27 - 2700K 30 - 3000K	ND - Non Dimmable 11 - 0-10V Dimming DA - DALI	0	US





Job Name/Date:

Fixture Type Designation:

## SUGGESTED POWER SUPPLIES

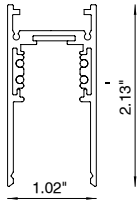
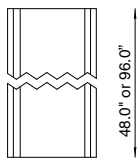
48VDC - See Track Datasheets

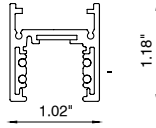
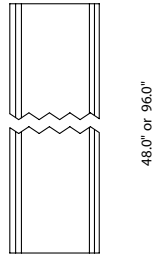
### 48V TRACKS

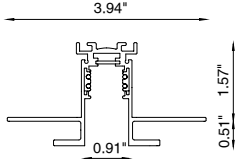
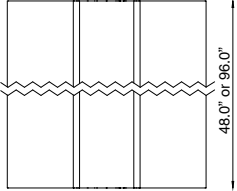
<p><b>B55</b></p>   <p>See B55 Track datasheet for ordering code and power supply</p> 	<p><b>B30</b></p>   <p>See B30 Track datasheet for ordering code and power supply</p> 	<p><b>B-INSIDE</b></p>   <p>See B-Inside Track datasheet for ordering code and power supply</p> 
--	---	---

## PHOTOMETRIC DATA

All photometry is 3000K

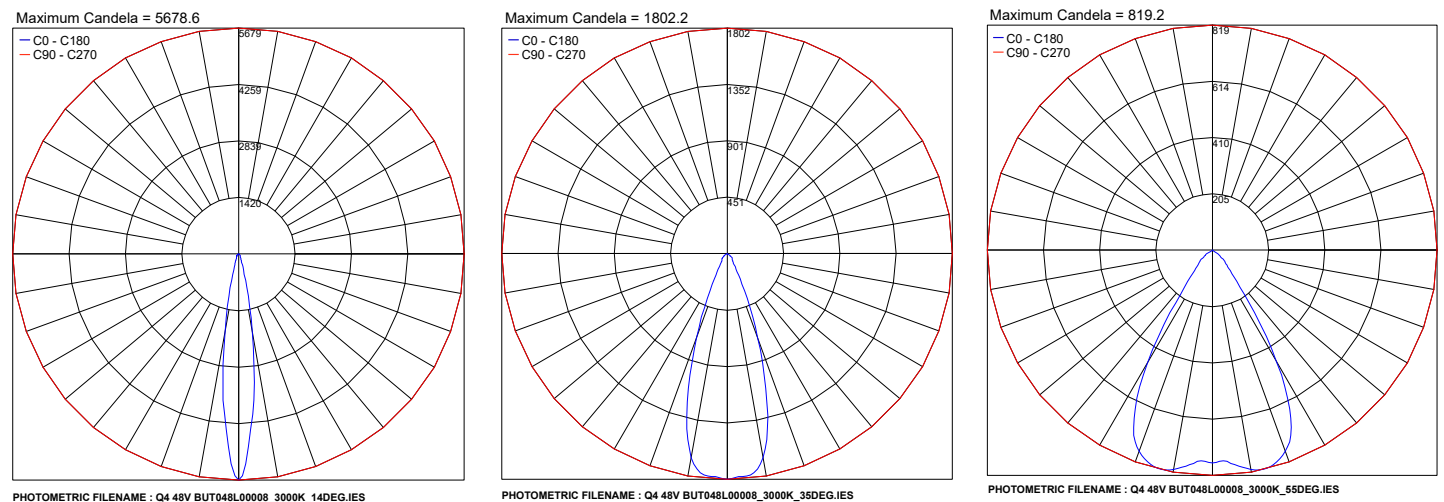

Job Name/Date:

Fixture Type Designation: