

Design

Mammini + Candido

# RAZOR IP44



Razor IP44/IP65 is a totally disappearing modular system made of Coral WaterOut®, installable on plasterboard and ceilings. A razorblade of light slashing the darkness, highlighting paths, defining outdoor spaces. Razor can be used in multiple modules with one or two counterposed light sources that illuminate its internal body. Integrated inside walls or ceilings, it creates bright settings with a unique and suggestive appeal.



designplan® 

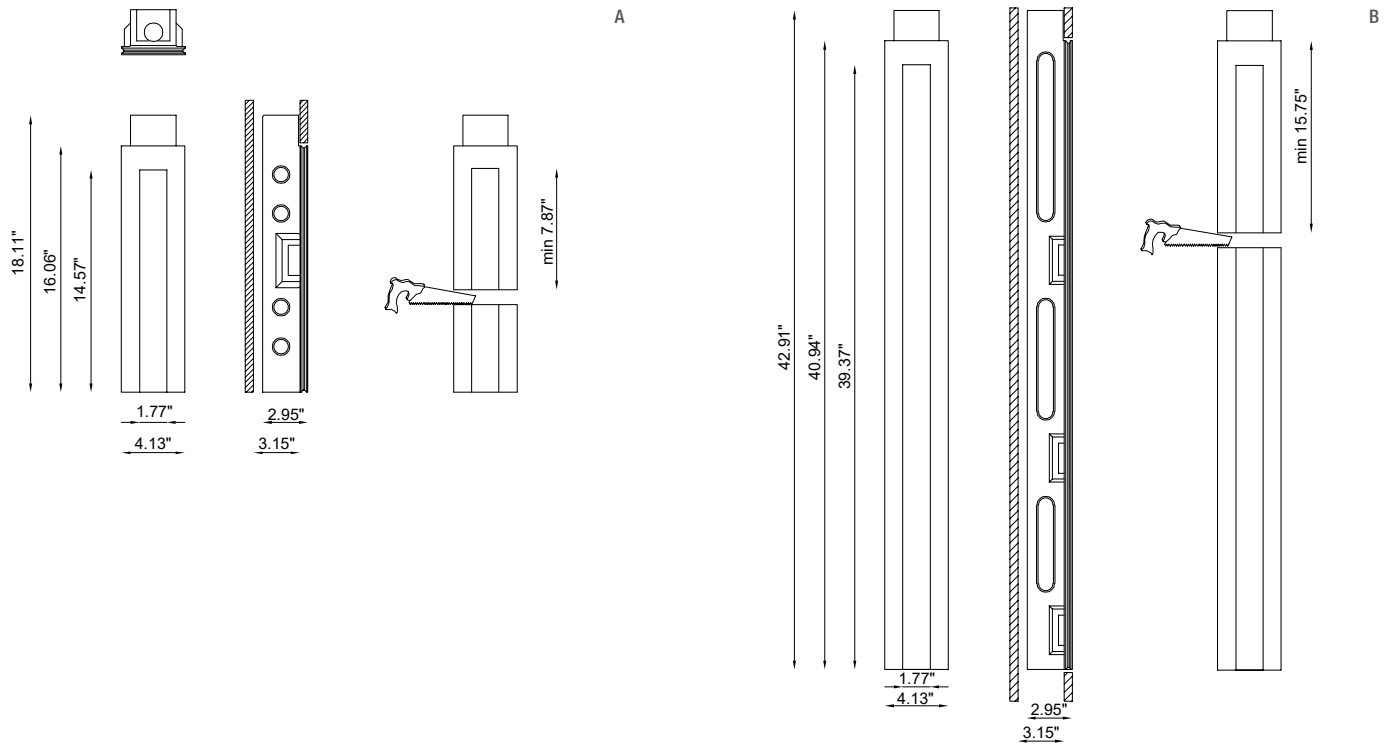

### TECHNICAL FEATURES | ELECTRIFIED BODY

Code	BU6965.CW.US (fig. A)	BU6966.CW.US (fig. B)
Type	Downlight 90°   Wall recessed 90° 	Downlight 90°   Wall recessed 90° 
Material	CW: Coral WaterOut®	CW: Coral WaterOut®
Weight	6.17 lbs	13.67 lbs
Mounting	Wall and ceiling recessed	Wall and ceiling recessed
IP rating	IP44	IP44
Cut out for plasterboard	16.34" x 4.53"	41.34" x 4.53"
Lamp type	LED 	LED 
Lamp wattage	2W - 500mA	2W - 500mA
Luminous efficacy	75 lm/W - 3000K	75 lm/W - 3000K
Light distribution	Narrow beam 14°	Narrow beam 14°
Fitting	-	-
Light color	White 3000K White 2700K (on request)	White 3000K White 2700K (on request)
Light hole	14.57" x 1.77"	39.37" x 1.77"
Voltage connection	60Hz	60Hz
CRI	>90	>90
Note	It is possible to cut the electrified body to obtain a light hole 7.87" minimum.	It is possible to cut the electrified body to obtain a light hole 15.75" minimum.

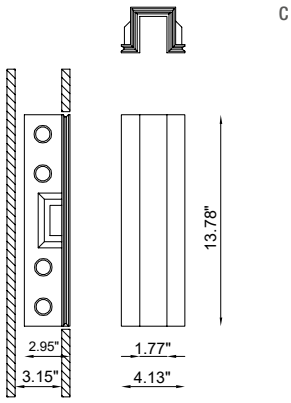

C

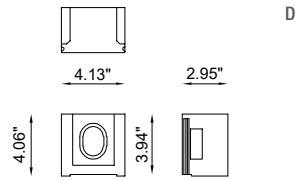

D

TECHNICAL FEATURES | MODULAR BODY

Code	<b>BU6964.CW.US</b> (fig. C)
Material	CW: Coral WaterOut®
Weight	4.41 lbs
IP rating	-
Cut out for plasterboard	13.78" (for each module installed) x 4.53"
Light hole	13.78" (for each module installed) x 1.77"
Note	

TECHNICAL FEATURES | CLOSURE HEADPARTS

Code	<b>BU6963.CW.US</b> (fig. D)
Material	CW: Coral WaterOut®
Weight	1.54 lbs
IP rating	-
Cut out for plasterboard	4.53" x 4.53"
Light hole	-
Note	Can be used in alternative to a further electrified body (code <b>BU6965.CW.US</b> / <b>BU6966.CW.US</b> / <b>BU6987.CW.US</b> / <b>BU6988.CW.US</b> ) to close a continuous line of the Razor IP44 product.

EXAMPLES OF INSTALLATION

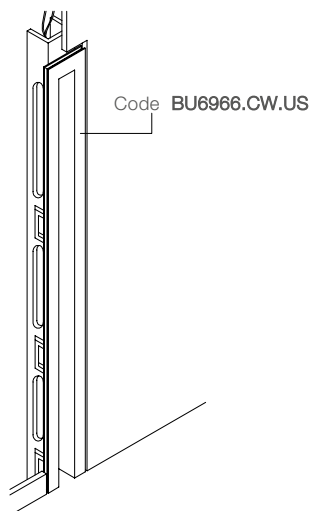
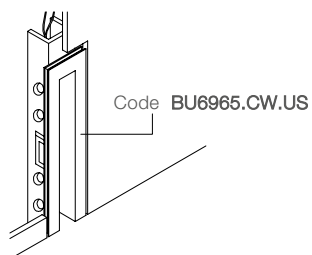

Singular module  
1 electrified body

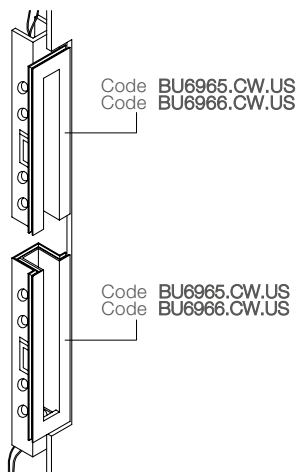

2 electrified bodies  
in opposite position

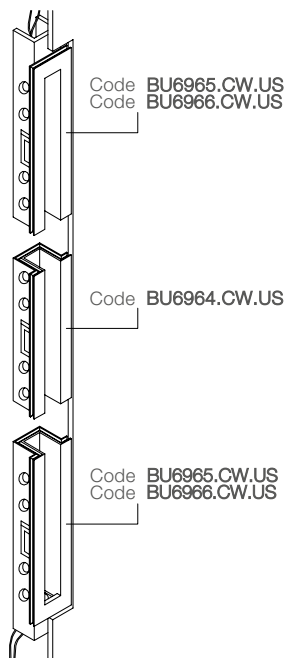

2 electrified bodies in opposite position  
1 modular body

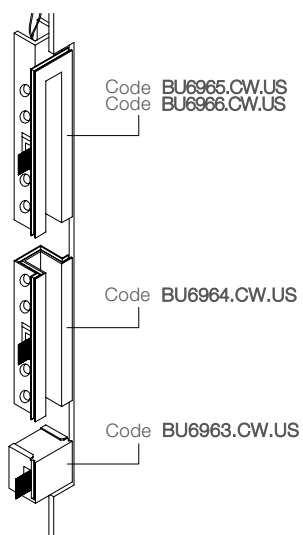

1 electrified body  
1 modular body  
1 closure headpart

