

RONDÒ 3.4
3000K, 8W, radial,
micro-blasted stainless steel



designplan™ 

79 Trenton Avenue
Frenchtown, NJ 08825

www.designplan.com

Tel: (908) 996-7710
Fax: (908) 996-7042

RONDÒ

OUTDOOR STEP LIGHTS
DRIVE-OVER FOR ORIENTATION LIGHTS IN PATHS AND PARKING AREAS

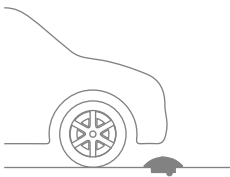

2700K 3000K 4000K

Ø3.94"

Ø6.30"

SINGLE BEAM



RONDÒ 1.1
2W 24VDC



RONDÒ 3.1
3W 24VDC



RONDÒ 2.1
2W 24VDC

DOUBLE BEAM



RONDÒ 1.2
4W 24VDC



RONDÒ 3.2
5W 24VDC

4 BEAMS

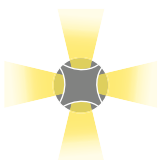

RONDÒ 3.4
8W 24VDC



BUILT-IN PROTECTION SYSTEMS:

PID PROTECTIVE IMPEDANCE DEVICE (RONDÒ 3)



IPS INTELLIGENT PROTECTION SYSTEM

CONTROLLED UPWARD BEAM AVOIDS LIGHT POLLUTION

TAMPER-RESISTANT SCREW IN AISI 316L STAINLESS STEEL IN THE SAME FINISH AS THE FIXTURE



5-STEP MATERIAL PROTECTION, AND OXIDATION AND CORROSION RESISTANCE

Preparation for painting with ALODINE NT-E® coating
Epoxy paint
Polyester paint
Paints compliant with Qualicoat automotive coating standard
Salt spray tested (over 1000 hours)



RONDÒ

UNIQUE SELLING POINTS

RAL FINISH
ON REQUEST



DRIVE-OVER
UP TO 11023 lbs



BODY IN AISI 316L
STAINLESS STEEL, MADE
ENTIRELY ON A CNC LATHE



SCREEN IN
ANTI-UV
POLYCARBONATE

10° OPTICS



RADIAL OPTICS



DOUBLE-BEAM
RADIAL OPTICS



RONDÒ 1 / 2

✓
RONDÒ 1.2
 3000K, 4W, radial, micro-blasted stainless steel
LIRA 1.0
 3000K, 6W, asymmetrical, anthracite
UPDOWN 3.6
 3000K, 6W, 15°, anodized gray

Project by / arch. Patrik Spreafico
 Plastic Stratosfera, Robbiate, Lecco, Italy



RONDÒ 1.1

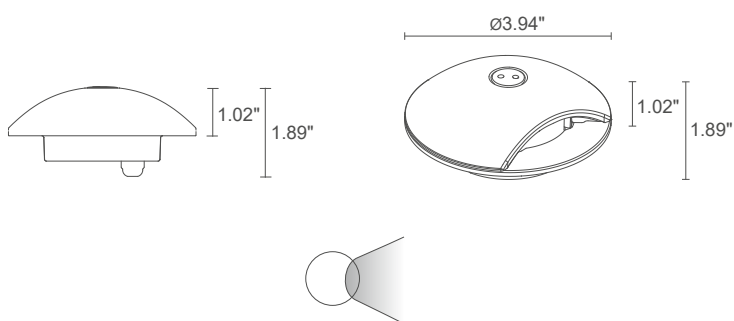

11023.1 lbs 1.3 lbs **IP67 IK08**

POWER / POWER SUPPLY 2W 24VDC
MODEL NO. **RD1100** **H** - Anthracite
RD1100 **I** - Micro-blasted stainless steel
RD1100 **T** - Cor-ten

LED COLOR	F - 2700K 5 - 3000K 9 - 4000K
OPTICS	S - 10° A - radial
POWER CABLES	includes 4.92' neoprene cable H05RN-F 0.08"x0.01"/0.03" Ø0.25" 1 - 16.40' 2 - 32.81' 3 - 49.21' 4 - 65.62'
LUMEN OUTPUT AT SOURCE	185 lm (3000K)
DELIVERED LUMEN OUTPUT	65 lm (3000K, radial optics)
NO. AND TYPE OF LED	1 power LED 1/4 ANSI BIN, 50000h L95 B10 (Ta 25°C)
MATERIAL	body in AISI 316L stainless steel lens in Rilsan® Clear
POWER SUPPLY UNIT	power supply required, not included
MOUNTING	recessed (ground)
ACCESSORIES	see accessories page



RONDÒ 1.2

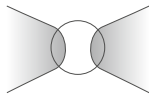
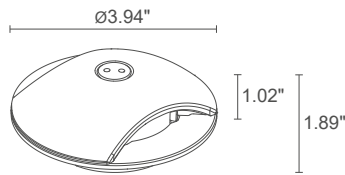

11023.1 lbs 1.3 lbs IP67 IK08



4W 24VDC
RD1200 ■ H - ■ Anthracite
RD1200 ■ I - ■ Micro-blasted stainless steel
RD1200 ■ T - ■ Cor-ten

■	F - 2700K 5 - 3000K 9 - 4000K
■	S - 10° A - radial
■	includes 4.92' neoprene cable H05RN-F 0.08"x0.01"/0.03" Ø0.25" 1 - 16.40' 2 - 32.81' 3 - 49.21' 4 - 65.62'

185 lm (3000K) per beam

65 lm (3000K, radial optics) per beam

2 power LEDs
1/4 ANSI BIN, 50000h L95 B10 (Ta 25°C)

body in AISI 316L stainless steel
lens in Rilsan® Clear

power supply required, not included

recessed (ground)

see accessories page



RONDÒ 2.1

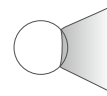
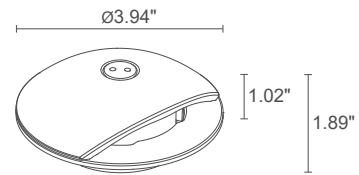

11023.1 lbs 1.6 lbs IP67 IK08



2W 24VDC
RD2100 ■ H - ■ Anthracite
RD2100 ■ I - ■ Micro-blasted stainless steel
RD2100 ■ T - ■ Cor-ten

■	F - 2700K 5 - 3000K 9 - 4000K
■	S - 10° A - radial
■	includes 4.92' neoprene cable H05RN-F 0.08"x0.01"/0.03" Ø0.25" 1 - 16.40' 2 - 32.81' 3 - 49.21' 4 - 65.62'

185 lm (3000K)

85 lm (3000K, radial optics)

1 power LED
1/4 ANSI BIN, 50000h L95 B10 (Ta 25°C)

body in AISI 316L stainless steel
lens in Rilsan® Clear

power supply required, not included

recessed (ground)

see accessories page

RONDÒ 3



RONDÒ 3.1

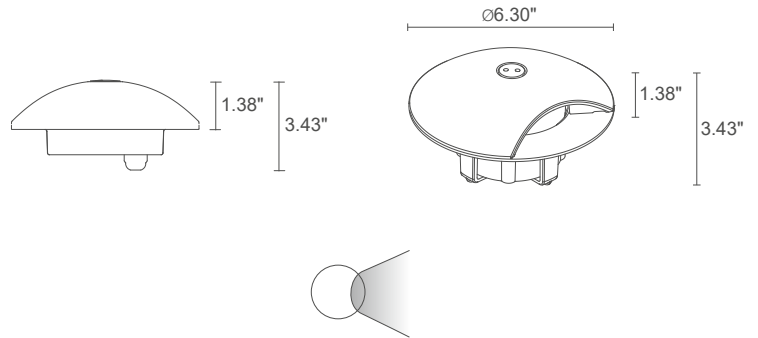

11023.1 lbs 4.4 lbs IP67 IK08



POWER / POWER SUPPLY
MODEL NO.

3W 24VDC

RD3100 H - Anthracite

RD3100 I - Micro-blasted stainless steel

RD3100 T - Cor-ten

LED COLOR

F - 2700K

5 - 3000K

9 - 4000K

OPTICS

S - 10°

A - radial

POWER CABLES

includes 4.92' neoprene cable
H05RN-F 0.08"x0.01"/0.03" Ø0.25"
1 - 16.40'
2 - 32.81'
3 - 49.21'
4 - 65.62'

LUMEN OUTPUT AT SOURCE

185 lm (3000K)

DELIVERED LUMEN OUTPUT

90 lm (3000K, radial optics)

NO. AND TYPE OF LED

1 power LED
1/4 ANSI BIN, 50000h L95 B10 (Ta 25°C)

MATERIAL

body in AISI 316L stainless steel
lens in Rilsan® Clear

POWER SUPPLY UNIT

power supply required, not included

MOUNTING

recessed (ground)

ACCESSORIES

see accessories page

✓
RONDÒ 3.4
3000K, 8W, radial, micro-blasted stainless steel
Light planning by / Cristian Turra
Private residence, Iseo, Brescia, Italy





RONDÒ 3.2

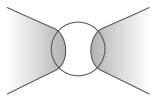
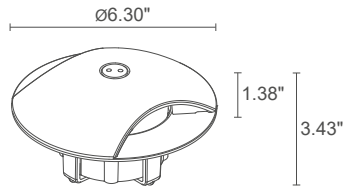

11023.1 lbs 4.0 lbs IP67 IK08



5W 24VDC

RD3200 H - Anthracite
RD3200 I - Micro-blasted stainless steel
RD3200 T - Cor-ten

<ul style="list-style-type: none"> ■ F - 2700K ■ 5 - 3000K ■ 9 - 4000K
<ul style="list-style-type: none"> ■ S - 10° ■ A - radial
<ul style="list-style-type: none"> ■ includes 4.92' neoprene cable H05RN-F 0.08"x0.01"/0.03" Ø0.25" 1 - 16.40' 2 - 32.81' 3 - 49.21' 4 - 65.62'
185 lm (3000K) per beam
90 lm (3000K, radial optics) per beam
2 power LEDs 1/4 ANSI BIN, 50000h L95 B10 (Ta 25°C)
body in AISI 316L stainless steel lens in Rilsan® Clear
power supply required, not included
recessed (ground)
see accessories page



RONDÒ 3.4

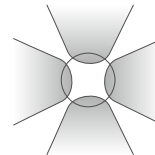
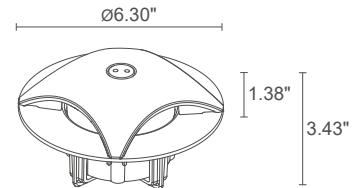

11023.1 lbs 4.2 lbs IP67 IK08



8W 24VDC

RD3400 H - Anthracite
RD3400 I - Micro-blasted stainless steel
RD3400 T - Cor-ten

<ul style="list-style-type: none"> ■ F - 2700K ■ 5 - 3000K ■ 9 - 4000K
<ul style="list-style-type: none"> ■ S - 10° ■ A - radial
<ul style="list-style-type: none"> ■ includes 4.92' neoprene cable H05RN-F 0.08"x0.01"/0.03" Ø0.25" 1 - 16.40' 2 - 32.81' 3 - 49.21' 4 - 65.62'
185 lm (3000K) per beam
90 lm (3000K, radial optics) per beam
4 power LEDs 1/4 ANSI BIN, 50000h L95 B10 (Ta 25°C)
body in AISI 316L stainless steel lens in Rilsan® Clear
power supply required, not included
recessed (ground)
see accessories page

RONDÒ

ACCESSORIES

ACCESSORIES FOR INSTALLATION



WC0100
Outer casing
(Rondò 1.1 / 1.2 / 2.1)



WC0103
Outer casing
(Rondò 1.1 / 1.2 / 2.1)



WC0150
Outer casing
(Rondò 1.1 / 1.2 / 2.1)



WC0601
Outer casing
(Rondò 3.1 / 3.2 / 3.4)



WC0701
Outer casing
(Rondò 3.1 / 3.2 / 3.4)

POWER CABLES Rondò 1.1 / 1.2 / 2.1; Rondò 3.1 / 3.2 24VDC version

the choice of power cable is included in the configuration of the code for the lighting fixture

- 1 - 16.40'
- 2 - 32.81'
- 3 - 49.21'
- 4 - 65.62'

Neoprene cables
includes 4.92' neoprene cable
H05RN-F 0.08"x0.01"/0.03" Ø0.25"

RONDÒ 1.2

3000K, 4W, radial, micro-blasted stainless steel

Project by / Studio di Architettura Andrea Abbadessa,
ing. Ignazio Stancanelli, ing. Giuseppe Malatino Light
planning by / Light Style
Maniace-Ortigia, Syracuse, Italy



RONDÒ

OUTDOOR STEP LIGHTS

RONDÒ 1.1

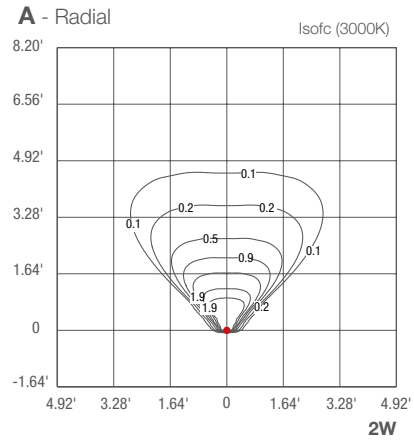
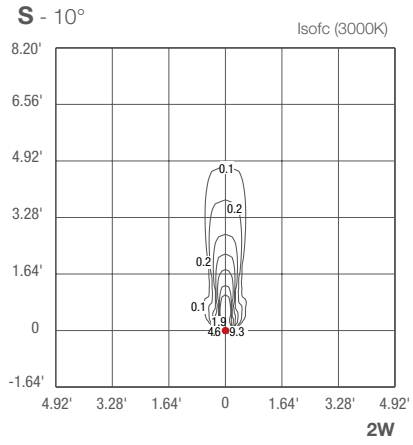

RONDÒ 2.1

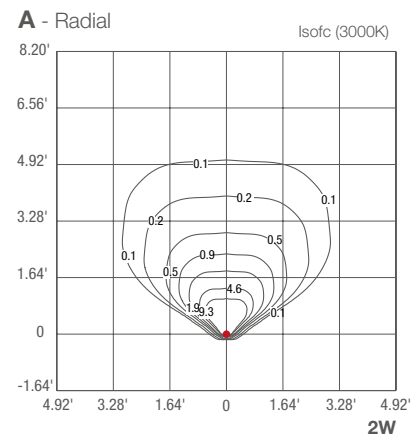
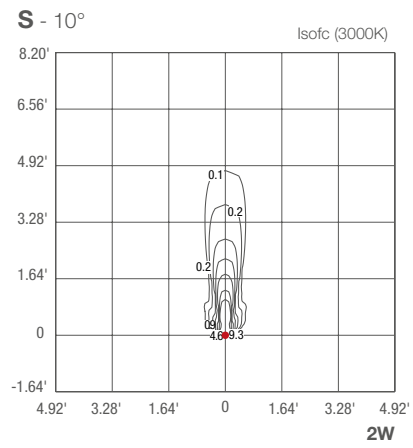

RONDÒ 3.1

