

Siri is a line of spotlights for indoor and outdoor applications with outstanding design featuring rounded angles. The scaled and adjustable bracket allows multiple installations on ceiling, wall, and floor.



## TECHNICAL DATA

|                           |   |
|---------------------------|---|
| <b>Wattage / Input</b>    | 16W (24VDC)   |
| <b>Power Supply</b>       | Remote, not included. See page 2.   |
| <b>Construction</b>       | Body: Die-Cast Aluminum<br>Lens: Tempered, Serigraphed Extra-Clear Glass<br>Cable Length: 4.92' |
| <b>CCT</b>                | 2700K, 3000K, 4000K, 5000K  |
| <b>CRI</b>                | >80   |
| <b>BUG Rating</b>         | B1-U0-G0 (3000K)  |
| <b>Delivered Lumens</b>   | 925 lm (3000K, 30°)   |
| <b>Efficacy</b>           | 57.8 lm/W (3000K, 30°)  |
| <b>Optics</b>             | 5 Standard (see below)  |
| <b>Finishes</b>           | 4 Standard, Custom RAL (see below)  |
| <b>Fixture Dimensions</b> | 2.28" l x 4.84" w x 10.00" h  |
| <b>Fixture Weight</b>     | 3.53 lbs  |
| <b>LED Source</b>         | 4 Power LEDs  |
| <b>Lumen Maintenance</b>  | L95, B10 >50,000hrs (Ta 25°C)   |
| <b>Color Consistency</b>  | 1/4 ANSI BIN  |
| <b>Operating Temp.</b>    | -4°F to +113°F  |
| <b>IP Rating</b>          | IP66  |
| <b>Impact Rating</b>      | IK06  |

Fixture Dimensions

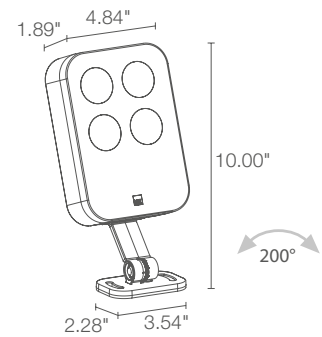

## ORDERING INFORMATION

*Example: SR20105ME or SR20105ME-1. Accessories / Power Supplies ordered separately.*

| SR2010    |  |  |  |  |
|-----------|--|--|--|--|
| Model No. | CCT  | Optics   | Finish   | Cable Length   |
| SR2010    | F - 2700K<br>5 - 3000K<br>9 - 4000K<br>0 - 5000K | V - 6°<br>S - 12°<br>M - 30°<br>L - 40°<br>W - 10° x 45° | E - White<br>F - Gray<br>H - Anthracite<br>T - Cor-ten<br>C - Custom RAL<br><i>(Consult factory for "C")</i> | 4.92' standard<br>1 - 16.40'<br>2 - 32.81'<br>3 - 49.21'<br>4 - 65.62' |

Job Name/Date:

Fixture Type Designation:

## SUGGESTED POWER SUPPLIES

24VDC

| Part Number               | Description   | Input/Output                       | # of Fixtures |
|---------------------------|---|------------------------------------|---------------|
| <a href="#">PPLT00056</a> | Non-Dim   | 120-277VAC to 24VDC, 26W, Class 2  | 1-1           |
| <a href="#">PPLT00157</a> | Non-Dim   | 120VAC to 24VDC, 60W, Class 2      | 1-3           |
| <a href="#">PPLT00284</a> | Non-Dim   | 120-277VAC to 24VDC, 100W, Class 2 | 1-5           |
| <a href="#">PPLT00543</a> | 0-10V Dimming to 15% (-40°C / -40°F cold weather start) | 120-277VAC to 24VDC, 100W, Class 2 | 1-5           |

For other power supply options consult factory.

## ACCESSORIES

### Installation



**WP0300**  
Ground Spike

## ACCESSORIES

### Anti-Glare

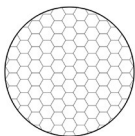

**WH5020**  
Honeycomb Louvre  
*Not available for 6° optic*



**WB5020H**  
Anti-glare hood - Anthracite finish  
*On request the finish can match the fixture*

Job Name/Date:

Fixture Type Designation:

## PHOTOMETRIC DATA

Note all Photometry is 3000K

### V - 6°

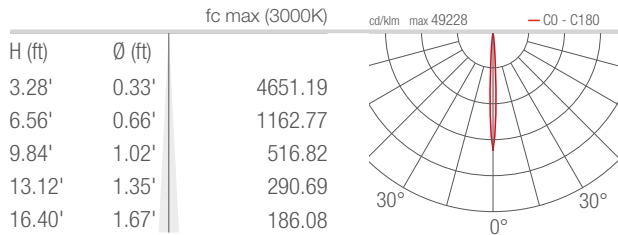

### S - 12°

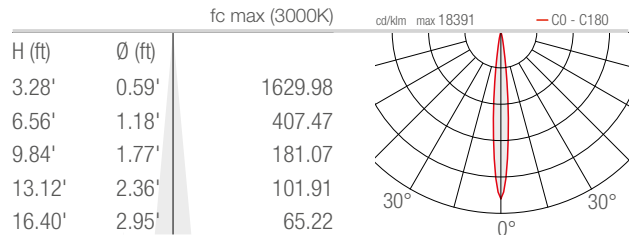

### M - 30°

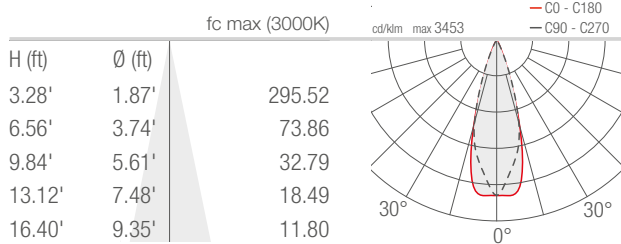

### L - 40°

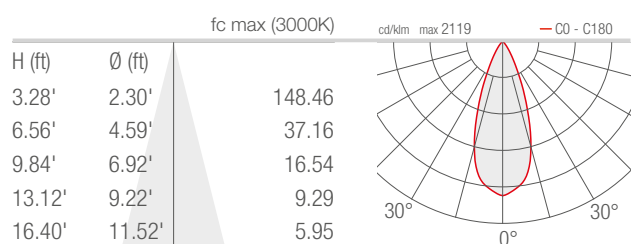

### W - 10°x45°

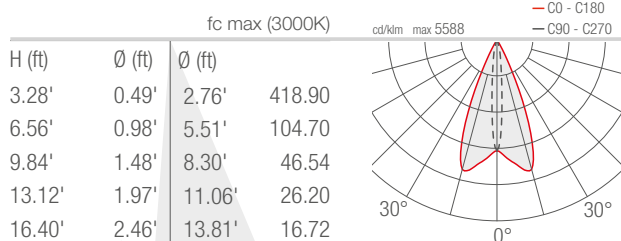

Job Name/Date:

Fixture Type Designation: