

Siri is a line of spotlights for indoor and outdoor applications with outstanding design featuring rounded angles. The scaled and adjustable bracket allows multiple installations on ceiling, wall, and floor.



## TECHNICAL DATA

<b>Wattage / Input</b>	16W (24VDC)
<b>Power Supply</b>	Remote, not included. See page 2.
<b>Construction</b>	Body: Die-Cast Aluminum Lens: Tempered, Serigraphed Extra-Clear Glass Cable Length: 4.92'
<b>CCT</b>	2700K, 3000K, 4000K, 5000K
<b>CRI</b>	>80
<b>BUG Rating</b>	B1-U0-G0 (3000K)
<b>Delivered Lumens</b>	925 lm (3000K, 30°)
<b>Efficacy</b>	57.8 lm/W (3000K, 30°)
<b>Optics</b>	5 Standard (see below)
<b>Finishes</b>	4 Standard, Custom RAL (see below)
<b>Fixture Dimensions</b>	3.11" l x 5.31" w x 11.30" h
<b>Fixture Weight</b>	4.30 lbs
<b>LED Source</b>	4 Power LEDs
<b>Lumen Maintenance</b>	L95, B10 >50,000hrs (Ta 25°C)
<b>Color Consistency</b>	1/4 ANSI BIN
<b>Operating Temp.</b>	-4°F to +113°F
<b>IP Rating</b>	IP66
<b>Impact Rating</b>	IK06

Fixture Dimensions

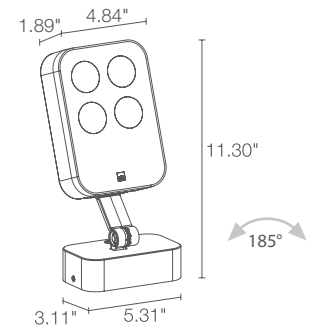

## ORDERING INFORMATION

Example: SR21105ME. Accessories / Power Supplies ordered separately.

SR2110			
Model No.	CCT	Optics	Finish
SR2110	F - 2700K 5 - 3000K 9 - 4000K 0 - 5000K	V - 6° S - 12° M - 30° L - 40° W - 10° x 45°	E - White F - Gray H - Anthracite T - Cor-ten C - Custom RAL (Consult factory for "C")

Job Name/Date:

Fixture Type Designation:

## SUGGESTED POWER SUPPLIES

24VDC

Part Number	Description	Input/Output	# of Fixtures
<a href="#">PPLT00056</a>	Non-Dim	120-277VAC to 24VDC, 26W, Class 2, IP66	1-1
<a href="#">PPLT00586</a>	Non-Dim	120-277VAC to 24VDC, 40W, Class 2	1-2
<a href="#">PPLT00709</a>	ELV/TRIAC & 0-10V Dimming to 5% and OFF	120-277VAC to 24VDC, 96W, Class 2, DAMP	1-4
<a href="#">PPLT00543</a>	0-10V Dimming to 15% (-40°C / -40°F cold weather start)	120-277VAC to 24VDC, 100W, Class 2	1-5

## Suggested Lutron Compatible

Part Number	Option	Lutron SKU	Dim Range	Description	Input/Output	# of Fixtures
<a href="#">PPLT00273</a>	L3DAE / L3DA3W	L3DA	100%-1%	Hi-Lume™ 1% EcoSystem™ or 1% 3-Wire LED Driver	120-277VAC to 24VDC, 40W, Class 2	1-2
<a href="#">PPLT00530</a>	L3D0	L3D0	100%-0.1%	Hi-Lume™ Premier 0.1% or Ecosystem 3-Wire LED Driver	120-277VAC to 24VDC, 96W, Class 2	1-4

For other power supply options consult factory.

## ACCESSORIES

### Anti-Glare

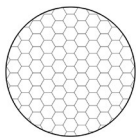

#### WH5020

Honeycomb Louvre  
Not available for 6° optic



#### WB5020H

Anti-glare hood - Anthracite finish  
On request the finish can match the fixture

Job Name/Date:

Fixture Type Designation:

## PHOTOMETRIC DATA

Note all Photometry is 3000K

### V - 6°

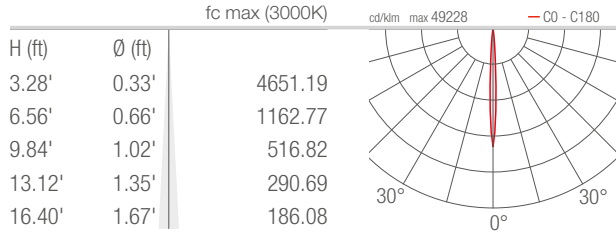

### S - 12°

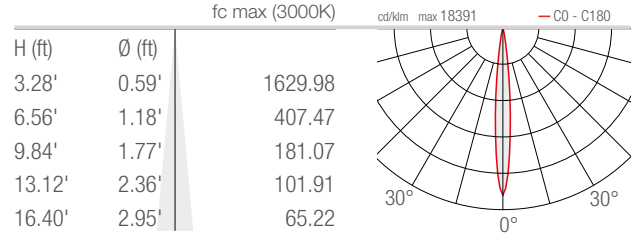

### M - 30°

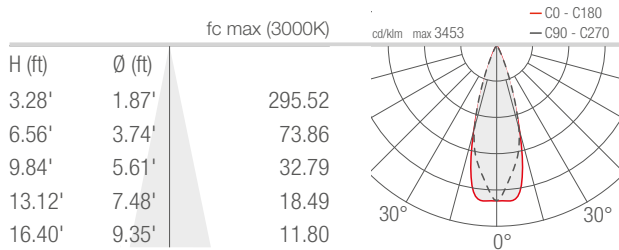

### L - 40°

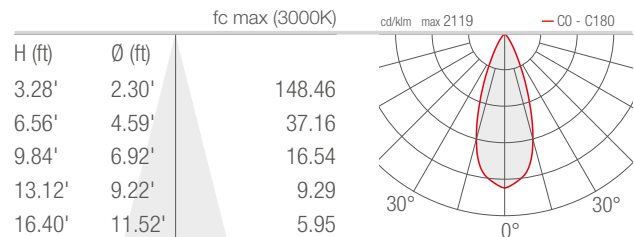

### W - 10°x45°

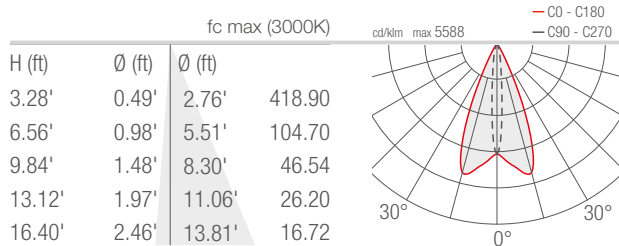

Job Name/Date:

Fixture Type Designation: