

SMOOTHY 1.0

The Smoothy 1 Series are walkover rated LED ingrade uplights for outdoor use with no visible screws. Can also be a downlight when used with the fixing springs accessory. **The Bright 1, Smoothy 1 and Litus 1 series all use the same LED.**

TECHNICAL DATA

Wattage / Input	2W (700mA)
Power Supply	Remote, not included. See page 2.
Construction	Body: Anodized aluminium Trim: AISI 316L Stainless Steel or Brass Lens: Tempered, transparent extra-clear glass (optics version); Sandblasted (diffuse version) Cable Length: 4.9' standard
CCT	2700K, 3000K, 4000K
CRI	CRI >80, CRI >90
BUG Rating	B0-U2-G0 (3000K, P) B0-U3-G0 (3000K, S, M, F, L, D)
Delivered Lumens	188 lm (3000K, 700mA, 22°, CRI 80) 165 lm (3000K, 700mA, 22°, CRI 90)
Efficacy	94 lm/W (3000K, 700mA, 22°, CRI 80) 83 lm/W (3000K, 700mA, 22°, CRI 90)
Optics	6 Standard (see below)
Finishes	Stainless Steel or Bronze, Custom RAL
Fixture Dimensions	Ø2.13" x 2.52"
Cut-out Dimension	Ø1.89" (for ceiling installations)
Fixture Weight	0.60 lbs
LED Source	1 Power LED
Lumen Maintenance	L90, B10 >50,000hrs (Ta 25°C)
Color Consistency	1/4 ANSI BIN
Operating Temp.	-4°F to +113°F
IP Rating	IP67
IK Rating	IK07



Fixture Dimensions

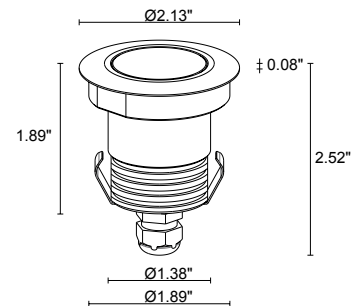

ORDERING INFORMATION

Example: SY101215MI or SY101215MI-3. Accessories / Power Supplies ordered separately

SY1012						
Model No.	CRI	CCT	Optics		Trim	Cable Length
SY1012	0 - 80 CRI 1 - 90 CRI	F - 2700K 5 - 3000K 9 - 4000K	S - 13° M - 22° F - 30°	P - 35° sharp L - 48° D - Diffuse	I - Stainless Steel L - Brass C - Custom RAL <i>(consult factory for "C")</i>	4.92' standard 1 - 16.40' 2 - 32.81' 3 - 49.21' 4 - 65.62'

Job Name/Date:

Fixture Type Designation:

SUGGESTED POWER SUPPLIES

700mA

Part Number	Description	Input/Output	# of Fixtures
PPLT00537	Non-Dim	120-277VAC to 700mA, 4W, Class 2	1-1
PPLT00466-P	0-10V Dimming to 1.0%	120-277VAC to 700mA, 10W, Class 2	1-3
PPLT00498	Phase Dim (120V Only)	120VAC to 700mA, 12W, Class 2	2-4
PPLT00465-P	0-10V Dimming to 1.0%	120-277VAC to 700mA, 20W, Class 2	1-10
PPLT00308-P	0-10V Dimming to 0.1%	120-277VAC to 700mA, 30W, Class 2	1-15
PPLT00480-P	0-10V Dimming to 1.0%	120-277VAC to 700mA, 30W, Class 2	1-15
PPLT00261	Leading/Trailing Edge Dimming to 10% (120V only)	120-277VAC to 700mA, 32W, Class 2	7-12

Suggested Lutron Compatible

Part Number	Option	Lutron SKU	Dim Range	Description	Input/Output	# of Fixtures
PPLT00515	L3DAE / L3DA3W	L3DA	100%-1%	Hi-Lume™ 1% EcoSystem™ or 1% 3-Wire LED Driver	120-277VAC to 700mA, 14W, Class 2	3-5
PPLT00181	L3DAE / L3DA3W	L3DA	100%-1%	Hi-Lume™ 1% EcoSystem™ or 1% 3-Wire LED Driver	120-277VAC to 700mA, 38W, Class 2	11-15

For other power supply options consult factory.

ACCESSORIES

Anti-Glare

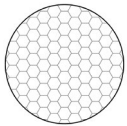

WH0100
Honeycomb Louvre
Not available for diffuse optics

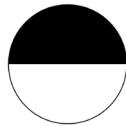

WE0700S
Anti-glare screen
Half transparent,
half serigraphed black
Not available for diffuse optics

ACCESSORIES

Installation



WC4010
Outer Casing
For ingrade use



WG0501
Fixing spring
For ceiling use



WL0100
Suction cup fixture
removal tool

Job Name/Date:

Fixture Type Designation:

PHOTOMETRIC DATA

Note all photometry in 3000K, CRI 80

S - 13° CRI 80

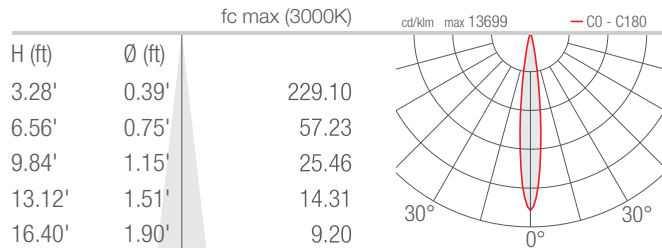

M - 22° CRI 80

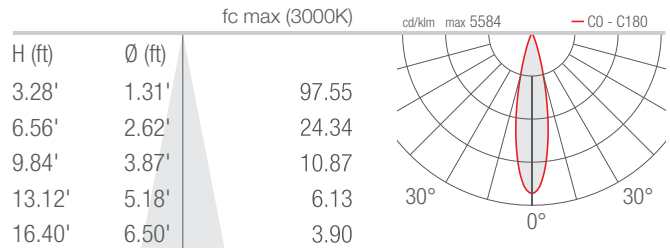

F - 30° CRI 80

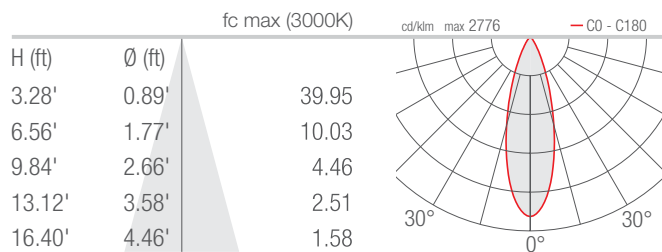

P - 35° sharp CRI 80

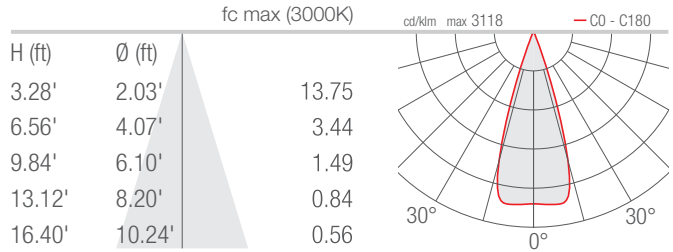

L - 48° CRI 80

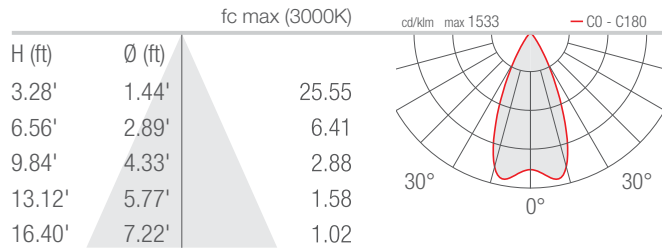

D - Diffuse CRI 80

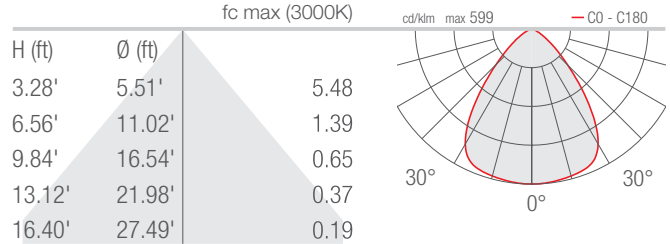

Job Name/Date:

Fixture Type Designation: