

SMOOTHY 1.6

The Smoothy 1 Series are walkover rated LED ingrade uplights for outdoor use with no visible screws. Can also be a downlight when used with the fixing springs accessory. **The Bright 1, Smoothy 1 and Litus 1 series all use the same LED.**

TECHNICAL DATA

Wattage / Input	2.5W, 3.5W (24VDC)
Power Supply	Remote, not included. See page 2.
Construction	Body: Anodized aluminium Trim: AISI 316L Stainless Steel or Brass Lens: Tempered, transparent extra-clear glass (optics version); Sandblasted (diffuse version) Cable Length: 4.9' standard
CCT	2700K, 3000K, 4000K
CRI	CRI >80, CRI >90
BUG Rating	B0-U2-G0 (3000K, P) B0-U3-G0 (3000K, S, M, F, L, D)
Delivered Lumens	See Delivered Lumens Table below
Efficacy	50-56 lm/W (3000K, 2.5W) 47-54 lm/W (3000K, 3.5W)
Optics	6 Standard (see below)
Finishes	Stainless Steel or Brass, Custom RAL
Fixture Dimensions	Ø2.13" x 2.52" h
Cut-out Dimension	Ø1.89" (for ceiling installations)
Fixture Weight	0.60 lbs
LED Source	1 Power LED
Lumen Maintenance	L90, B10 >50,000hrs (Ta 25°C)
Color Consistency	1/4 ANSI BIN
Operating Temp.	-4°F to +113°F
IP Rating	IP67
IK Rating	IK07



Fixture Dimensions

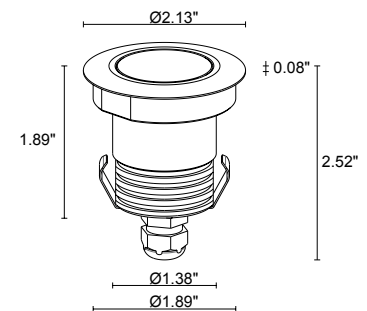

Delivered Lumens (3000K, 22°)	2.5W	3.5W
CRI 80	141 lm	188 lm
CRI 90	125 lm	165 lm

ORDERING INFORMATION

Example: SY160105MI or SY160105MI-2. Accessories / Power Supplies ordered separately.

Model No.	Wattage	CRI	CCT	Optics	Trim	Cable Length
SY160	0 - 2.5W 1 - 3.5W	0 - 80 CRI 1 - 90 CRI	F - 2700K 5 - 3000K 9 - 4000K	S - 13° P - 35° sharp M - 22° L - 48° F - 30° D - Diffuse	I - Stainless Steel L - Brass C - Custom RAL (consult factory for "C")	4.92' standard 1 - 16.40' 2 - 32.81' 3 - 49.21' 4 - 65.62'

Job Name/Date:

Fixture Type Designation:

SUGGESTED POWER SUPPLIES

24VDC

Part Number	Description	Input/Output	# of Fixtures	
			2.5W	3.5W
PPLT00632	0-10V Dimming (Dim to Off)	120-277VAC to 24VDC, 12W, Class 2	1-3	1-2
PPLT00056	Non-Dim	120-277VAC to 24VDC, 26W, Class 2, IP66	1-8	1-5
PPLT00586	Non-Dim	120-277VAC to 24VDC, 40W, Class 2	1-12	1-9
PPLT00158	Non-Dim	120VAC to 24VDC, 100W, Class 2	1-32	1-22
PPLT00543	0-10V Dimming to 15% (-40°C / -40°F cold weather start)	120-277VAC to 24VDC, 100W, Class 2	4-32	3-22

Suggested Lutron Compatible

Part Number	Option	Lutron SKU	Dim Range	Description	Input/Output	# of Fixtures	
						2.5W	3.5W
PPLT00273	L3DAE / L3DA3W	L3DA	100%-1%	Hi-Lume™ 1% EcoSystem™ or 1% 3-Wire LED Driver	120-277VAC to 24VDC, 40W, Class 2	1-12	1-9
PPLT00530	L3DAE / L3D0	L3DA/L3D0	100%-1%	Hi-Lume™ 0.1% EcoSystem™ or 3-Wire LED Driver	120-277VAC to 24VDC, 96W, Class 2	1-30	1-21

For other power supply options consult factory.

ACCESSORIES

Installation



WC4010
Outer Casing
For in-grade use



WG0501
Fixing spring
For ceiling use



WL0100
Suction cup fixture
removal tool

ACCESSORIES

Anti-Glare

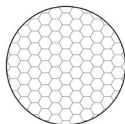

WH0100
Honeycomb Louvre
Not available for diffuse optics

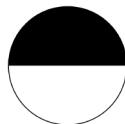

WE0700S
Anti-glare screen
Half transparent, half serigraphed black
Not available for diffuse optics

Job Name/Date:

Fixture Type Designation:

PHOTOMETRIC DATA

Note: All data in 3000K, CRI 80

S - 13° CRI 80

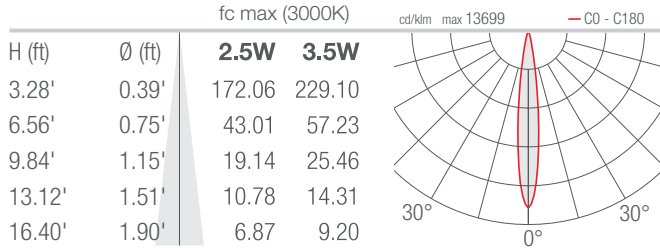

M - 22° CRI 80

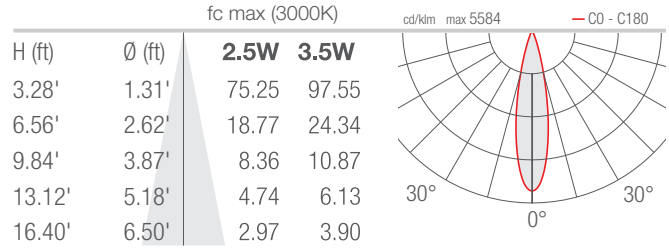

F - 30° CRI 80

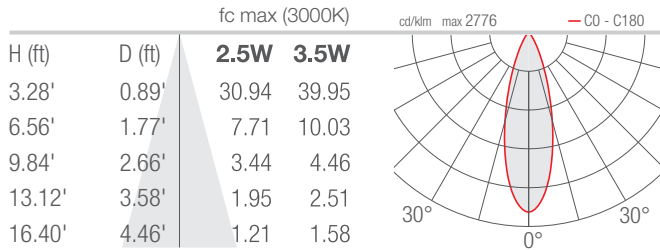

P - 35° sharp CRI 80

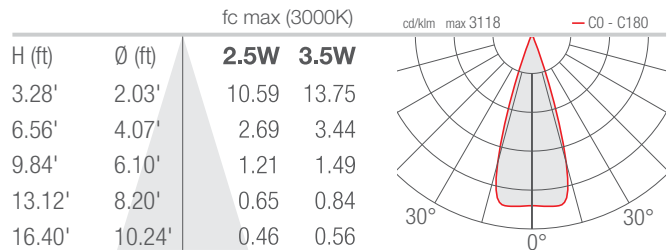

L - 48° CRI 80

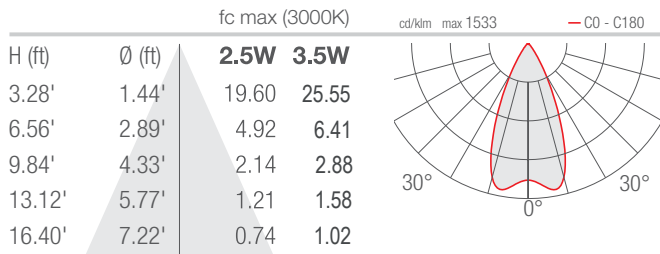

D - Diffuse CRI 80 (Smoothy 1.6)

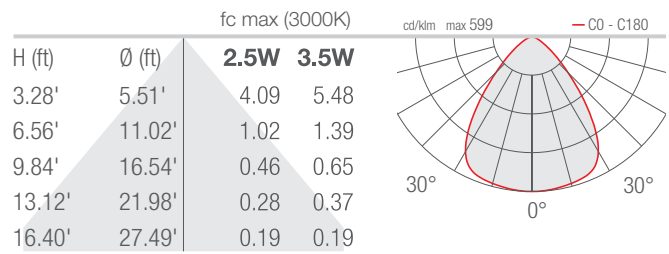

Job Name/Date:

Fixture Type Designation: