

# SMOOTHY 2.8

The Smoothy 2.8 is an adjustable walkover rated LED ingrade uplight for outdoor use with no visible screws. Can also be a downlight when used with the fixing springs accessory. **The Bright 2, Smoothy 2 and Litus 2 series all use the same LED.**

## TECHNICAL DATA

<b>Wattage / Input</b>	2.5W, 3.5W (24VDC)
<b>Power Supply</b>	Remote, not included. See page 2.
<b>Construction</b>	Body: Anodized aluminium Trim: AISI 316L Stainless Steel or Brass Lens: Tempered, transparent extra-clear glass (optics version) Cable Length: 4.9' standard
<b>CCT</b>	2700K, 3000K, 4000K <i>(3500K available, consult factory)</i>
<b>CRI</b>	CRI >80, CRI >90
<b>BUG Rating</b>	B0-U2-G0 (3000K, P) B0-U3-G0 (3000K, S, M, F, L)
<b>Delivered Lumens</b>	See Delivered Lumens Table below
<b>Efficacy</b>	50-56 lm/W (3000K, 2.5W) 47-54 lm/W (3000K, 3.5W)
<b>Optics</b>	6 Standard on tiltable ±15° (See below)
<b>Finishes</b>	Stainless Steel or Brass, Custom RAL
<b>Fixture Dimensions</b>	Ø3.31" x 2.52" h
<b>Cut-out Dimension</b>	Ø1.89" (for ceiling installations)
<b>Fixture Weight</b>	0.60 lbs
<b>LED Source</b>	1 Power LED
<b>Lumen Maintenance</b>	L90, B10 >50,000hrs (Ta 25°C)
<b>Color Consistency</b>	1/4 ANSI BIN
<b>Operating Temp.</b>	-4°F to +113°F
<b>IP Rating</b>	IP67
<b>IK Rating</b>	IK08



Fixture Dimensions

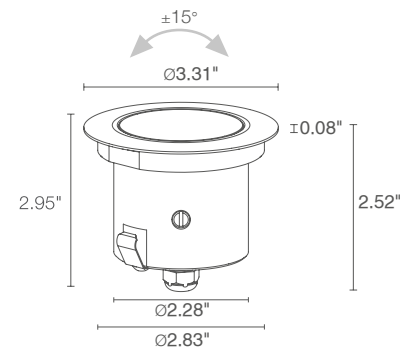

<b>Delivered Lumens (3000K, 22°)</b>	2.5W	3.5W
<b>CRI 80</b>	141 lm	188 lm
<b>CRI 90</b>	125 lm	165 lm

## ORDERING INFORMATION

Example: SY28001FSI or SY28001FSI-3. Accessories / Power Supplies ordered separately.

SY280						
Model No.	Wattage	CRI	CCT	Optics	Trim	Cable Length
SY280	0 - 2.5W 1 - 3.5W	0 - 80 CRI 1 - 90 CRI	F - 2700K 5 - 3000K 9 - 4000K	S - 13° M - 22° F - 30° P - 35° sharp L - 48°	I - Stainless Steel L - Brass C - Custom RAL <i>(consult factory for "C")</i>	4.92' standard 1 - 16.40' 2 - 32.81' 3 - 49.21' 4 - 65.62'

Job Name/Date:

Fixture Type Designation:

## SUGGESTED POWER SUPPLIES

24VDC

Part Number	Description	Input/Output	# of Fixtures	
			2.5W	3.5W
<a href="#">PPLT00632</a>	0-10V Dimming (Dim to Off)	120-277VAC to 24VDC, 12W, Class 2	1-3	1-2
<a href="#">PPLT00586</a>	Non-Dim	120-277VAC to 24VDC, 40W, Class 2	1-12	1-9
<a href="#">PPLT00709</a>	ELV/TRIAC & 0-10V Dimming to 5% and OFF	120-277VAC to 24VDC, 96W, Class 2, DAMP	1-30	1-21
<a href="#">PPLT00543</a>	0-10V Dimming to 15% (-40°C / -40°F cold weather start)	120-277VAC to 24VDC, 100W, Class 2	4-32	3-22

## Suggested Lutron Compatible

Part Number	Option	Lutron SKU	Dim Range	Description	Input/Output	# of Fixtures	
						2.5W	3.5W
<a href="#">PPLT00273</a>	L3DAE / L3DA3W	L3DA	100%-1%	Hi-Lume™ 1% EcoSystem™ or 1% 3-Wire LED Driver	120-277VAC to 24VDC, 40W, Class 2	1-12	1-9
<a href="#">PPLT00530</a>	L3DAE / L3D0	L3DA/L3D0	100%-1%	Hi-Lume™ 0.1% EcoSystem™ or 3-Wire LED Driver	120-277VAC to 24VDC, 96W, Class 2	1-30	1-21

For other power supply options consult factory.

## ACCESSORIES

### Installation



**WC4020**  
Outer Casing  
For ingrade use



**WG0502**  
Fixing spring  
For ceiling use



**WL0100**  
Suction cup fixture  
removal tool

## ACCESSORIES

### Anti-Glare

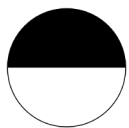

**WE0701S**  
Anti-glare lens, half transparent  
and half serigraphed black  
Not available for sharp optics

Job Name/Date:

Fixture Type Designation:

## PHOTOMETRIC DATA

Note: All data in 3000K, CRI 80

### S - 13° CRI 80

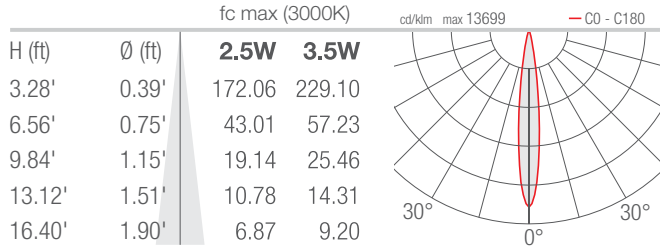

### M - 22° CRI 80

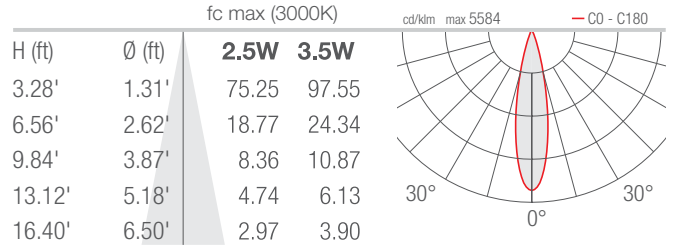

### F - 30° CRI 80

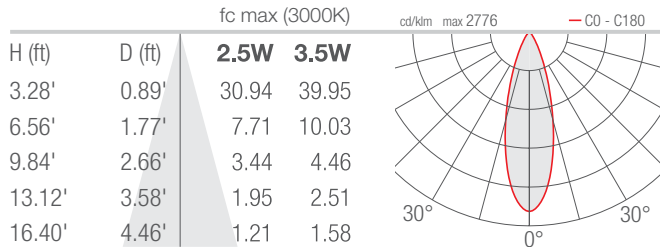

### P - 35° sharp CRI 80

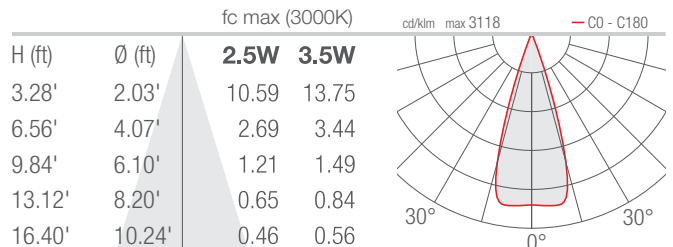

### L - 48° CRI 80

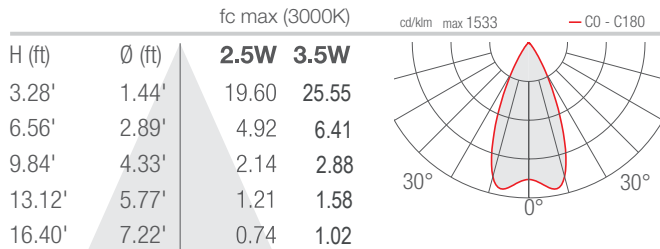

Job Name/Date:

Fixture Type Designation: