

# SMOOTHY 5.6

The Smoothy 5.6 is an adjustable walkover rated LED ingrade uplight for outdoor use with no visible screws. Can also be a downlight when used with the fixing springs accessory. Available in multiple wattages, CRI 80 or 90, RGB (7W only). **The Bright 3, Smoothy 5 and Litus 5 series all use the same LED.**

## TECHNICAL DATA

<b>Wattage / Input</b>	3.5W, 5W, 7W (24VDC); 7W (RGB, 700mA)
<b>Power Supply</b>	Remote, not included. See page 2.
<b>Construction</b>	Body: Anodized aluminium Trim: AISI 316L Stainless Steel Lens: Tempered, transparent extra-clear glass Cable Length: 4.9' standard
<b>CCT</b>	2700K, 3000K, 4000K, RGB
<b>CRI</b>	CRI >80, CRI >90
<b>Delivered Lumens</b>	See Delivered Lumens Chart (White) 235 lm: (R) 92 lm, (G) 105 lm, (B) 38 lm
<b>Efficacy</b>	57 - 70 lm/W (5W), 53 - 66 lm/W (7W) (White) 34 lm/W (RGB)
<b>Optics</b>	9 Standard (White), 4 Standard (RGB)
<b>Finishes</b>	Stainless Steel or Brass, Custom RAL
<b>Fixture Dimensions</b>	Ø 4.29" x 4.02" h
<b>Cut-out Dimension</b>	Ø 3.94"
<b>Fixture Weight</b>	1.43 lbs
<b>LED Source</b>	1 High Intensity Power LED (White), 3 power LEDs (RGB)
<b>Lumen Maintenance</b>	L90, B10 >50,000hrs (Ta 25°C)
<b>Color Consistency</b>	3-Step MacAdam (White)
<b>Operating Temp.</b>	-4°F to +113°F
<b>IP Rating</b>	IP67
<b>IK Rating</b>	IK08



Fixture Dimensions

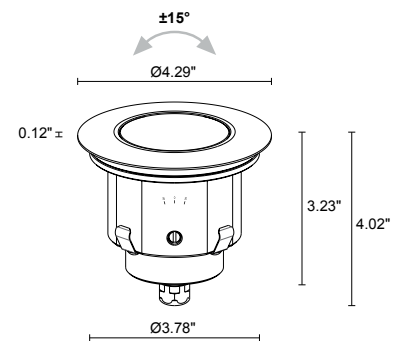

Delivered Lumens (3000K, 34°)	5W	7W
<b>CRI 80</b>	352 lm	463 lm
<b>CRI 90</b>	284 lm	374 lm

## ORDERING INFORMATION

Example: SY56010FVI or SY56010FVI-1 . Accessories / Power Supplies ordered separately.

Model #	Wattage	CRI	CCT	Optics (White)	Trim	Cable Length
SY56	00 - 3.5W	0 - CRI 80	F - 2700K	U - 5° (3.5W only) M - 34°	I - Stainless Steel	4.92' standard
	01 - 5W	1 - CRI 90	5 - 3000K	V - 8° L - 45°	L - Brass	1 - 16.40'
	02 - 7W		9 - 4000K* *3.5W 4000K for CRI 80 only	T - 11° Q - 61° sharp S - 17° L - 45° P - 21° sharp W - 13°x52°	C - Custom RAL (consult factory for "C")	2 - 32.81' 3 - 49.21' 4 - 65.62'
Model #	Wattage	CRI	CCT	Optics (RGB)		
SY56	32 - 7W (RGB)		6 - RGB	S - 20° L - 45° M - 34° W - 21°x42°		

Job Name/Date:

Fixture Type Designation:

## POWER SUPPLIES 24VDC

Part Number	Description	Input/Output	# of Fixtures		
			3.5W / 5W / 7W		
<a href="#">PPLT00149</a>	Non-Dim	120VAC to 24VDC, 10W, Class 2, IP65	1-2	1-1	1-1
<a href="#">PPLT00632</a>	0-10V Dimming (Dim to Off)	120-277VAC to 24VDC, 12W, Class 2	1-2	1-1	1-1
<a href="#">PPLT00056</a>	Non-Dim	120-277VAC to 24VDC, 26W, Class 2, IP66	1-5	1-4	1-2
<a href="#">PPLT00157</a>	Non-Dim	120VAC to 24VDC, 60W, Class 2	1-13	1-9	1-6
<a href="#">PPLT00599</a>	ELV / TRIAC & 0-10V Dimming (100 to 0%)	120-277VAC to 24VDC, 96W, Class 2	1-21	1-15	1-10
<a href="#">PPLT00158</a>	Non-Dim	120VAC to 24VDC, 100W, Class 2	1-22	1-16	1-11
<a href="#">PPLT00543</a>	0-10V Dimming to 15% (-40°C / -40°F cold weather start)	120-277VAC to 24VDC, 100W, Class 2	3-22	2-16	2-11

## 700mA - RGB

Part Number	Description	Input/Output	# of Fixtures
<a href="#">PPLT00244-P</a>	DMX / RDM (Must advise DMX addresses if not using RDM)	120-277VAC to 700mA, 50W, Class 2	1-5
<a href="#">PPLT00129-P</a>	DMX / RDM (Field Addressable)	120-277VAC to 700mA, 100W, Class 2	1-9

For other power supply options consult factory.

## ACCESSORIES Installation



**WC4050**  
Outer Casing  
For ingrade use



**WG0505**  
Fixing spring  
For ceiling use



**WL0500**  
Suction cup fixture  
removal tool

## ACCESSORIES Anti-Glare

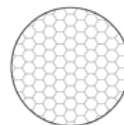

**WH0205**  
Honeycomb Louvre  
Not available for 21°  
sharp (P), 61° sharp (Q),  
8° (V) and 5° (U) optics.



**WE0702S**  
Anti-glare lens  
Half transparent and  
half serigraphed black  
Not available for diffuse or  
RGB optics

Job Name/Date:

Fixture Type Designation:

## PHOTOMETRIC DATA

Note: All data in 3000K, CRI 80

### U - 5° CRI 80

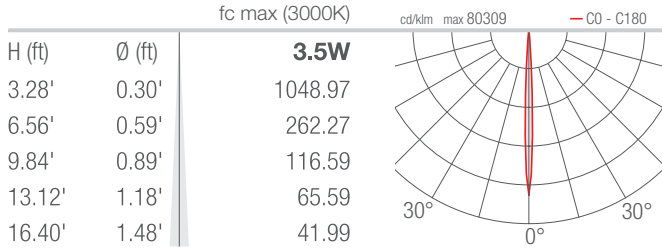

### V - 8° CRI 80

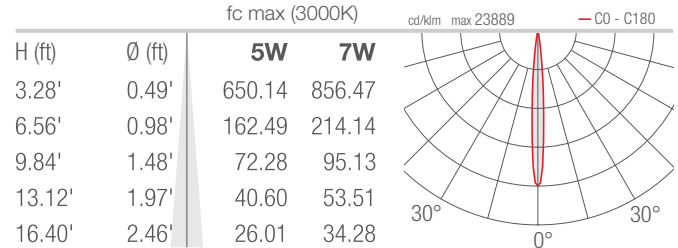

### T - 11° CRI 80

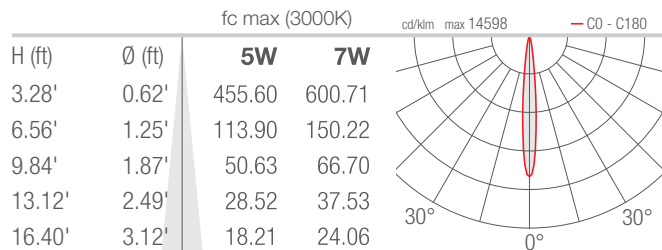

### S - 17° CRI 80

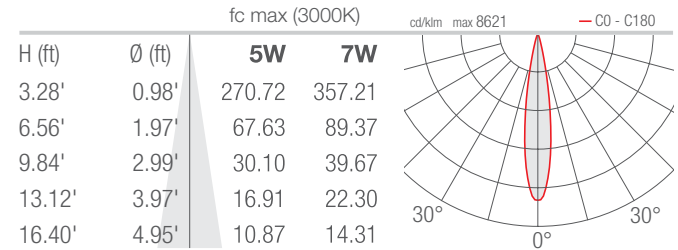

### P - 21° sharp CRI 80

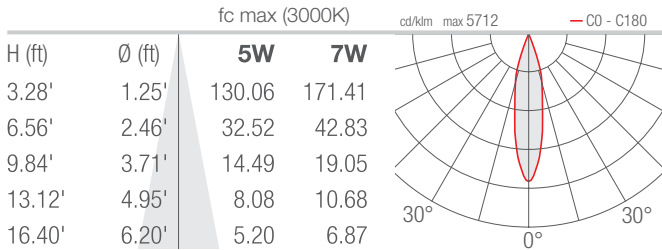

### M - 34° CRI 80

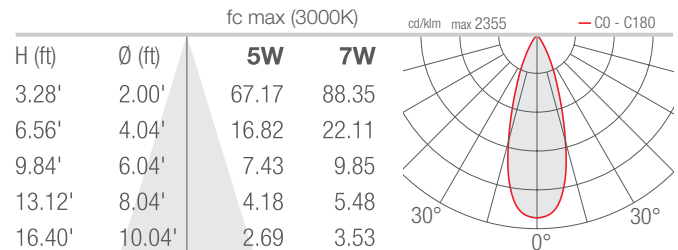

### L - 45° CRI 80

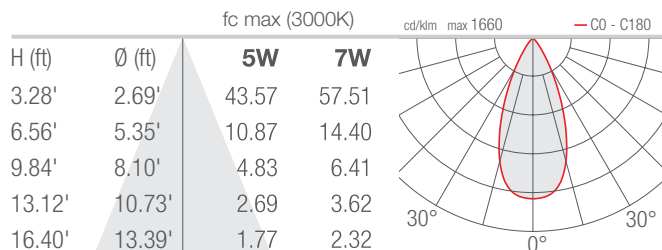

### Q - 61° sharp CRI 80

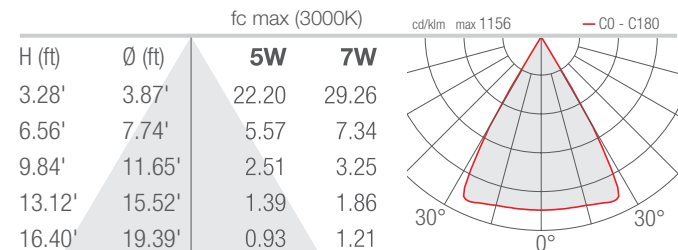

Job Name/Date:

Fixture Type Designation:

## PHOTOMETRIC DATA

Note: All data in 3000K, CRI 80

### W - 13°x52° CRI 80

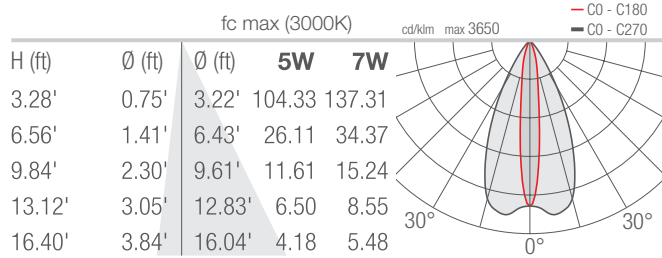

### D - Diffuse CRI 80 (Smoothy 2.4)

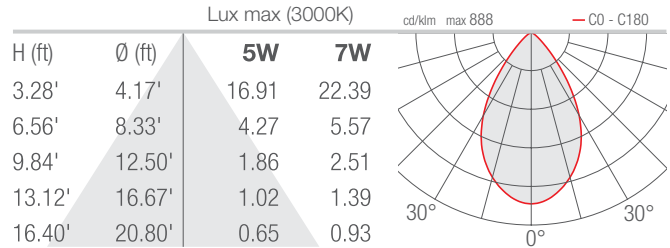

Job Name/Date:

Fixture Type Designation: