

SMOOTHY 5.6

The Smoothy 5.6 is an adjustable walkover rated LED ingrade uplight for outdoor use with no visible screws. Can also be a downlight when used with the fixing springs accessory. Available in multiple wattages, CRI 80 or 90, RGB (7W only). **The Bright 3, Smoothy 5 and Litus 5 series all use the same LED.**

TECHNICAL DATA

Wattage / Input	3.5W, 5W, 7W (24VDC); 7W (RGB, 700mA)
Power Supply	Remote, not included. See page 2.
Construction	Body: Anodized Aluminium Trim: AISI 316L Stainless Steel or Brass Lens: Tempered, Transparent Extra-clear Glass Cable Length: 4.9' standard
CCT	2700K, 3000K, 4000K, RGB
CRI	CRI >80, CRI >90
BUG Rating	B0-U3-G0 (3000K, all versions)
Delivered Lumens	See Delivered Lumens Chart (White) 235 lm: (R) 92 lm, (G) 105 lm, (B) 38 lm
Efficacy	57 - 70 lm/W (5W), 53 - 66 lm/W (7W) (White) 34 lm/W (RGB)
Optics	9 Standard (White), 4 Standard (RGB)
Finishes	Stainless Steel or Brass, Custom RAL
Fixture Dimensions	Ø 4.29" x 4.02" h
Cut-out Dimension	Ø 3.94"
Fixture Weight	1.43 lbs
LED Source	1 High Intensity Power LED (White), 3 power LEDs (RGB)
Lumen Maintenance	L90, B10 >50,000hrs (Ta 25°C)
Color Consistency	3-Step MacAdam (White)
Operating Temp.	-4°F to +113°F
IP Rating	IP67
IK Rating	IK08



Fixture Dimensions

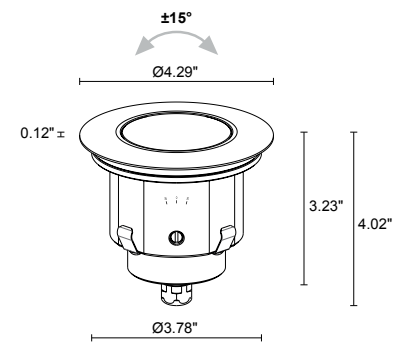

Delivered Lumens (3000K, 34°)	5W	7W
CRI 80	352 lm	463 lm
CRI 90	284 lm	374 lm

ORDERING INFORMATION

Example: SY56010FVI or SY56010FVI-1 . Accessories / Power Supplies ordered separately.

Model #	Wattage	CRI	CCT	Optics (White)	Trim	Cable Length	
SY56	00 - 3.5W	0 - CRI 80	F - 2700K	U - 5° (3.5W only) M - 34°	I - Stainless Steel	4.92' standard	
	01 - 5W	1 - CRI 90	5 - 3000K	V - 8° L - 45°	L - Brass	1 - 16.40'	
	02 - 7W			9 - 4000K*	T - 11° Q - 61° sharp	C - Custom RAL (consult factory for "C")	2 - 32.81'
				*3.5W 4000K for CRI 80 only	S - 17° W - 13°x52°		3 - 49.21'
			P - 21° sharp			4 - 65.62'	
Model #	Wattage	CRI	CCT	Optics (RGB)			
SY56	32 - 7W (RGB)		6 - RGB	S - 20° L - 45° M - 34° W - 21°x42°			

Job Name/Date:

Fixture Type Designation:

POWER SUPPLIES 24VDC

Part Number	Description	Input/Output	# of Fixtures		
			3.5W / 5W / 7W		
PPLT00149	Non-Dim	120VAC to 24VDC, 10W, Class 2, IP65	1-2	1-1	1-1
PPLT00632	0-10V Dimming (Dim to Off)	120-277VAC to 24VDC, 12W, Class 2	1-2	1-1	1-1
PPLT00056	Non-Dim	120-277VAC to 24VDC, 26W, Class 2, IP66	1-5	1-4	1-2
PPLT00157	Non-Dim	120VAC to 24VDC, 60W, Class 2	1-13	1-9	1-6
PPLT00627	ELV / TRIAC & 0-10V Dimming (100 to 0%), IP67	120-277VAC to 24VDC, 96W, Class 2	1-21	1-15	1-10
PPLT00158	Non-Dim	120VAC to 24VDC, 100W, Class 2	1-22	1-16	1-11
PPLT00543	0-10V Dimming to 15% (-40°C / -40°F cold weather start)	120-277VAC to 24VDC, 100W, Class 2	3-22	2-16	2-11

700mA - RGB

Part Number	Description	Input/Output	# of Fixtures
PPLT00244-P	DMX / RDM (Must advise DMX addresses if not using RDM)	120-277VAC to 700mA, 50W, Class 2	1-5
PPLT00129-P	DMX / RDM (Field Addressable)	120-277VAC to 700mA, 100W, Class 2	1-9

For other power supply options consult factory.

ACCESSORIES Installation



WC4050
Outer Casing
For ingrade use



WG0505
Fixing spring
For ceiling use



WL0500
Suction cup fixture
removal tool

ACCESSORIES Anti-Glare

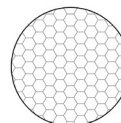

WH0205
Honeycomb Louvre
Not available for 21°
sharp (P), 61° sharp (Q),
8° (V) and 5° (U) optics.

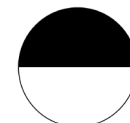

WE0702S
Anti-glare lens
Half transparent and
half serigraphed black
Not available for diffuse or
RGB optics

Job Name/Date:

Fixture Type Designation:

PHOTOMETRIC DATA

Note: All data in 3000K, CRI 80

U - 5° CRI 80

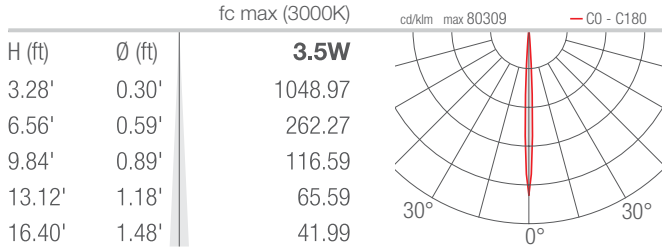

V - 8° CRI 80

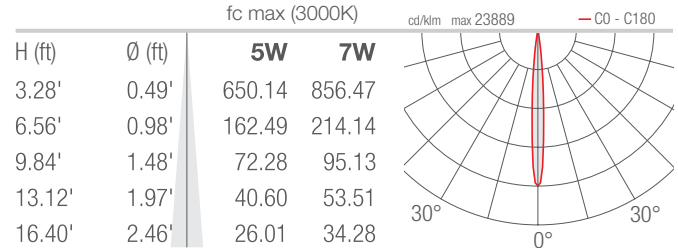

T - 11° CRI 80

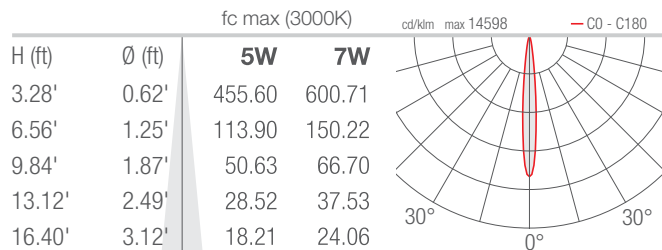

S - 17° CRI 80

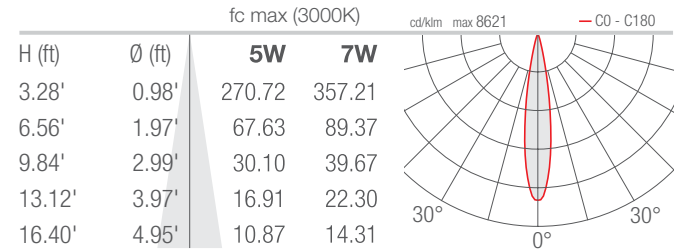

P - 21° sharp CRI 80

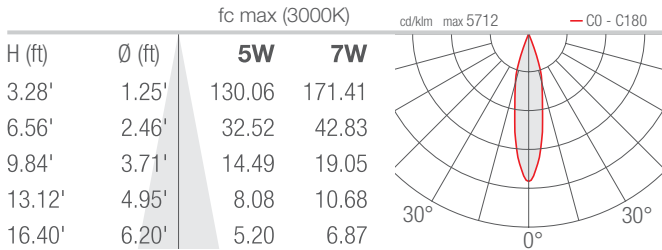

M - 34° CRI 80

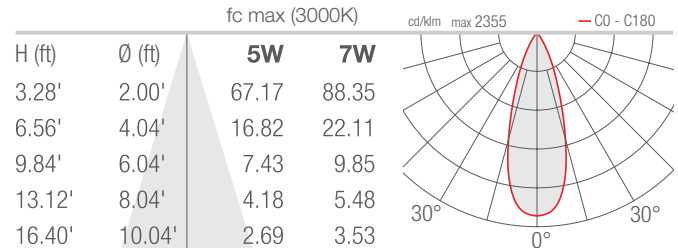

L - 45° CRI 80

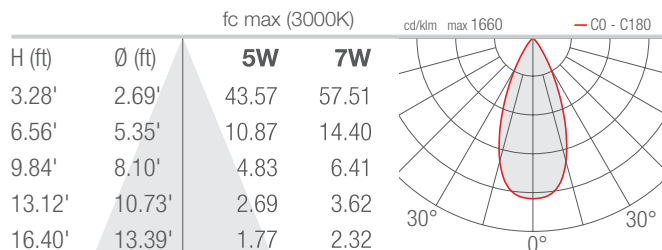

Q - 61° sharp CRI 80

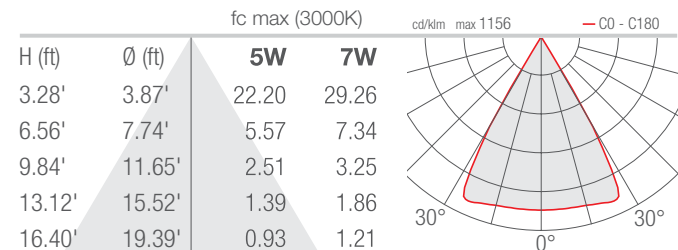

Job Name/Date:

Fixture Type Designation:

PHOTOMETRIC DATA

Note: All data in 3000K, CRI 80

W - 13°x52° CRI 80

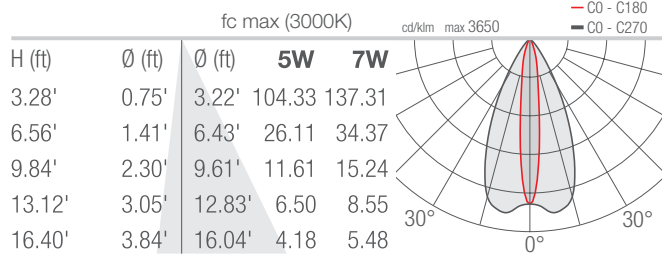

D - Diffuse CRI 80 (Smoothy 2.4)

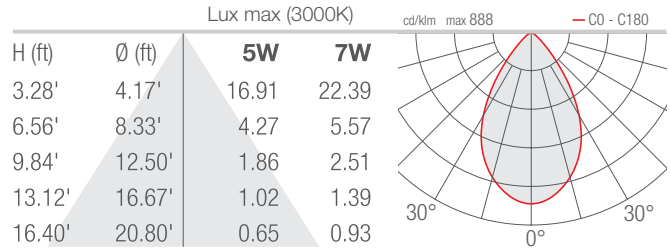

Job Name/Date:

Fixture Type Designation: