

The Spot 1 Series are compact floodlights for outdoor use available in white or blue light, with 5 optic options including 2 sharp which create a light beam with pin sharp edges. Not suitable for swimming pools or fountains.



TECHNICAL DATA

Wattage / Input	2W (24VDC)
Power Supply	Remote, not included. See page 2.
Construction	Body/Trim: AISI 316L Stainless Steel Lens: Transparent, Tempered Glass Cable Length: 4.9' standard
CCT	2700K, 3000K, 4000K, 5000K, Blue
CRI	>80
BUG Rating	B0-U1-G0 (4000K, 20°)
Delivered Lumens	88 lm (3000K)
Efficacy	44 lm/W
Optics	5 Standard (see below)
Finishes	Stainless Steel, Custom RAL
Fixture Dimensions	Ø1.2" x 2.2" l
Fixture Weight	0.88 lbs
LED Source	1 Power LED
Lumen Maintenance	L90, B10 >50,000hrs (Ta 25°C)
Color Consistency	1/4 ANSI BIN
Operating Temp.	-4°F to +113°F
IP Rating	IP68
IK Rating	IK10

Fixture Dimensions

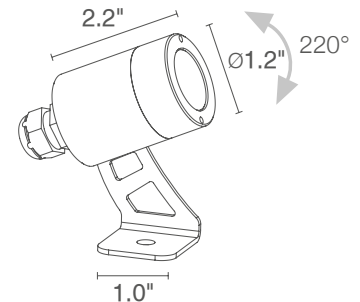

ORDERING INFORMATION

Example: CF16009MI or CF16009MI-2. Accessories / Power Supplies ordered separately.

CF1600				
Model No.	CCT	Optics	Finish	Cable Length
CF1600	F - 2700K 5 - 3000K 9 - 4000K 0 - 5000K 1 - Blue	S - 10° V - 19° sharp M - 20° L - 40° T - 54° sharp <i>The honeycomb louvre can be provided on all fixed optics, exception for 19° sharp (V) and 54° sharp (T) optics</i>	I - Stainless Steel C - Custom RAL <i>(consult factory for "C")</i>	4.92' standard 1 - 16.40' 2 - 32.81' 3 - 49.21' 4 - 65.62'

Job Name/Date:

Fixture Type Designation:

SUGGESTED POWER SUPPLIES

24VDC

Part Number	Description	Input/Output	# of Fixtures
PPLT00632	0-10V Dimming (Dim to Off)	120-277VAC to 24VDC, 12W, Class 2	1-4
PPLT00056	Non-Dim	120-277VAC to 24VDC, 26W, Class 2	1-10
PPLT00157	Non-Dim	120-277VAC to 24VDC, 60W, Class 2	1-24
PPLT00599	ELV / TRIAC & 0-10V Dimming (100 to 0%)	120-277VAC to 24VDC, 96W, Class 2	1-38
PPLT00284	Non-Dim	120-277VAC to 24VDC, 100W, Class 2	1-40
PPLT00543	0-10V Dimming to 15% (-40°C / -40°F cold weather start)	120-277VAC to 24VDC, 100W, Class 2	5-40

For other power supply options consult factory.

ACCESSORIES

Installation

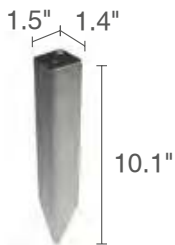

WP0100
Ground Spike (10.1")



WP1004
Fastener Strap

ACCESSORIES

Anti-Glare

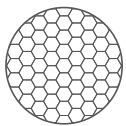

WH0101
Honeycomb Louvre
The honeycomb louvre can be provided on all fixed optics, exception for 19° sharp (V) and 54° sharp (T) optics



WB03201
Standard Shoot



WB03211
Asymmetrical Shoot

Job Name/Date:

Fixture Type Designation:

PHOTOMETRIC DATA

Note all photometry in 3000K

S - 10°

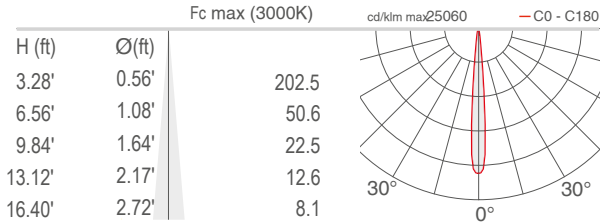

V - 19° sharp

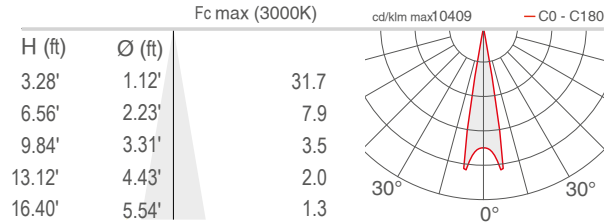

M - 20°

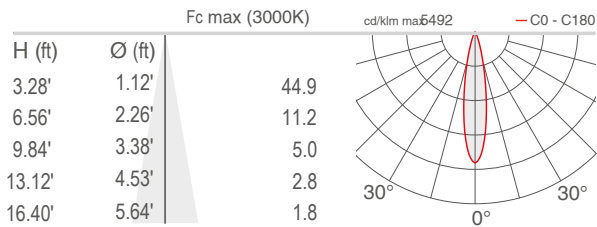

T - 54° sharp

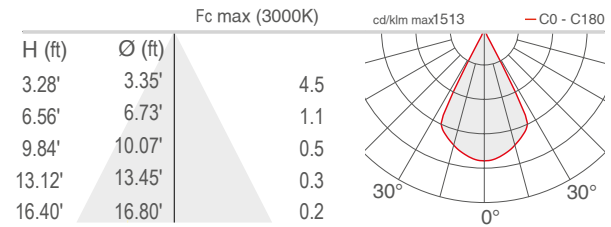

L - 40°

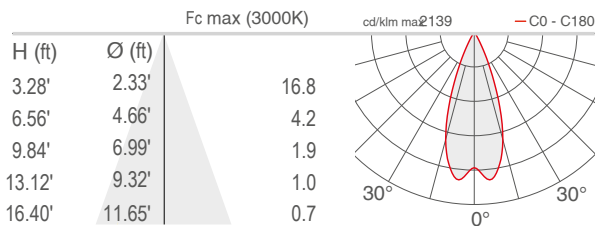

Job Name/Date:

Fixture Type Designation: