

The Spot 1 Series are compact floodlights for outdoor use available in white or blue light, with 5 optic options including 2 sharp which create a light beam with pin sharp edges. Not suitable for swimming pools or fountains.



## TECHNICAL DATA

<b>Wattage / Input</b>	2W (24VDC)
<b>Power Supply</b>	Remote, not included. See page 2.
<b>Construction</b>	Body/Trim: AISI 316L Stainless Steel Lens: Transparent, Tempered Glass Cable Length: 4.9' standard
<b>CCT</b>	2700K, 3000K, 4000K, 5000K, Blue
<b>CRI</b>	>80
<b>BUG Rating</b>	B0-U1-G0 (4000K, 20°)
<b>Delivered Lumens</b>	88 lm (3000K)
<b>Efficacy</b>	44 lm/W
<b>Optics</b>	5 Standard (see below)
<b>Finishes</b>	Stainless Steel, Custom RAL
<b>Fixture Dimensions</b>	Ø1.2" x 2.2" l
<b>Fixture Weight</b>	0.88 lbs
<b>LED Source</b>	1 Power LED
<b>Lumen Maintenance</b>	L90, B10 >50,000hrs (Ta 25°C)
<b>Color Consistency</b>	1/4 ANSI BIN
<b>Operating Temp.</b>	-4°F to +113°F
<b>IP Rating</b>	IP68
<b>IK Rating</b>	IK10

Fixture Dimensions

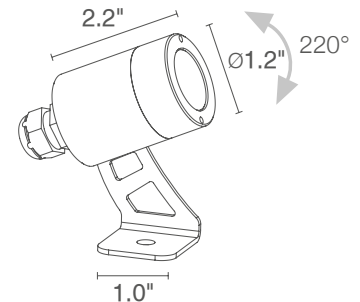

## ORDERING INFORMATION

Example: CF16009MI or CF16009MI-2. Accessories / Power Supplies ordered separately.

CF1600				
Model No.	CCT	Optics	Finish	Cable Length
CF1600	F - 2700K 5 - 3000K 9 - 4000K 0 - 5000K 1 - Blue	S - 10° V - 19° sharp M - 20° L - 40° T - 54° sharp  <i>The honeycomb louvre can be provided on all fixed optics, exception for 19° sharp (V) and 54° sharp (T) optics</i>	I - Stainless Steel C - Custom RAL <i>(consult factory for "C")</i>	4.92' standard 1 - 16.40' 2 - 32.81' 3 - 49.21' 4 - 65.62'

Job Name/Date:

Fixture Type Designation:

## SUGGESTED POWER SUPPLIES

24VDC

Part Number	Description	Input/Output	# of Fixtures
<a href="#">PPLT00632</a>	0-10V Dimming (Dim to Off)	120-277VAC to 24VDC, 12W, Class 2	1-4
<a href="#">PPLT00056</a>	Non-Dim	120-277VAC to 24VDC, 26W, Class 2	1-10
<a href="#">PPLT00586</a>	Non-Dim	120-277VAC to 24VDC, 40W, Class 2	1-16
<a href="#">PPLT00284</a>	Non-Dim	120-277VAC to 24VDC, 100W, Class 2	1-40
<a href="#">PPLT00543</a>	0-10V Dimming to 15% (-40°C / -40°F cold weather start)	120-277VAC to 24VDC, 100W, Class 2	5-40

## Suggested Lutron Compatible

Part Number	Option	Lutron SKU	Dim Range	Description	Input/Output	# of Fixtures
<a href="#">PPLT00273</a>	L3DAE / L3DA3W	L3DA	100%-1%	Hi-Lume™ 1% EcoSystem™ or 1% 3-Wire LED Driver	120-277VAC to 24VDC, 40W, Class 2	1-16
<a href="#">PPLT00530</a>	L3D0	L3D0	100%-0.1%	Hi-Lume™ Premier 0.1% or Ecosystem 3-Wire LED Driver	120-277VAC to 24VDC, 96W, Class 2	1-38

For other power supply options consult factory.

## ACCESSORIES

### Installation



**WP0100**  
Ground Spike (10.1")



**WP1004**  
Fastener Strap

## ACCESSORIES

### Anti-Glare

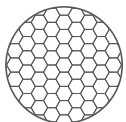

**WH0101**  
Honeycomb Louvre  
*The honeycomb louvre can be provided on all fixed optics, exception for 19° sharp (V) and 54° sharp (T) optics*



**WB03201**  
Standard Snoot



**WB03211**  
Asymmetrical Snoot

Job Name/Date:

Fixture Type Designation:

## PHOTOMETRIC DATA

Note all photometry in 3000K

### S - 10°

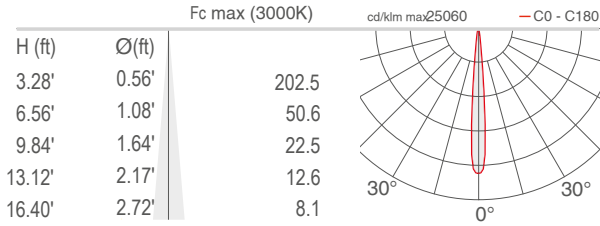

### V - 19° sharp

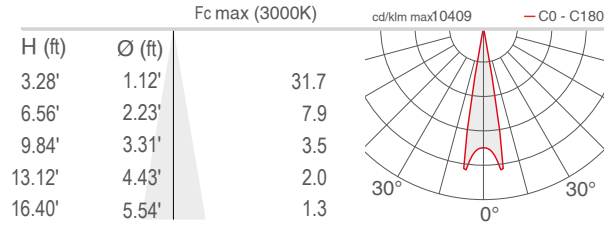

### M - 20°

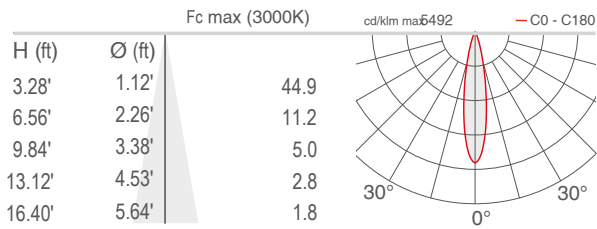

### T - 54° sharp

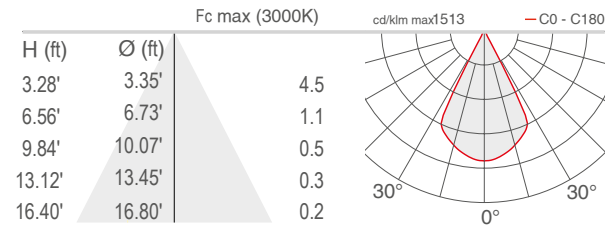

### L - 40°

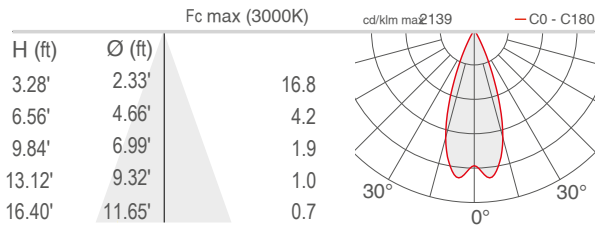

Job Name/Date:

Fixture Type Designation: