

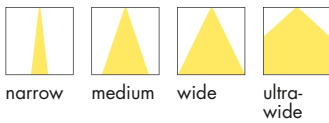

PROJECTORS FOR OUTDOOR APPLICATIONS DETAIL AND FACADE LIGHTING



Ø 1.18"

Ø 2.36"

Ø 3.31"

Ø 4.29"

CONSTANT CURRENT



SPOT 1.0

2W max 500mA

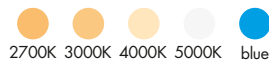

CONSTANT VOLTAGE



SPOT 1.6

2W 24VDC

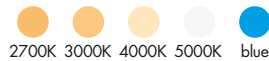

MAINS VOLTAGE



SPOT 2.4

8W 120VAC



SPOT 3.4

15W 120VAC



SPOT 4.4

22W/32W 24VDC



UNDERWATER

SPOT 316L

< SPOT 2.4
3000K, 8W, 58°, white, with asymmetrical snoot

Project by / arch. **Ciro Alfredo Matarante**
Photo by / **Alessio Tamborini**
Private residence, Foggia, Italy



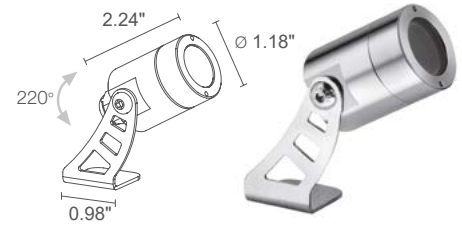
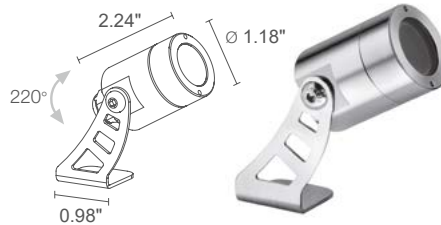
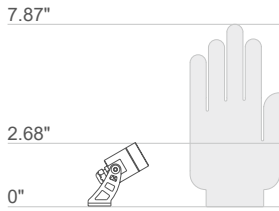

SPOT 1.0

SPOT 1.6



POWER / MODEL CODE	2W 500mA CF1012 ■ ■ ■ A I - ■
LED COLOR	F - 2700K 5 - 3000K 9 - 4000K 0 - 5000K 1 - blue
OPTICS	S - 10° V - 19° sharp M - 20° L - 40° T - 54° sharp
POWER CABLES	includes 4.92 ft neoprene cable H05RN-F 2x0.35/0.75 Ø 0.25" 1 - 16.40 ft 2 - 32.81 ft 3 - 49.21 ft 4 - 65.62 ft

POWER / MODEL CODE	2W 24VDC CF1600 ■ ■ ■ I - ■
LED COLOR	F - 2700K 5 - 3000K 9 - 4000K 0 - 5000K 1 - blue
OPTICS	S - 10° V - 19° sharp M - 20° L - 40° T - 54° sharp
POWER CABLES	includes 4.92 ft neoprene cable H05RN-F 2x0.35/0.75 Ø 0.25" 1 - 16.40 ft 2 - 32.81 ft 3 - 49.21 ft 4 - 65.62 ft

LUMEN OUTPUT AT SOURCE	145 lm (3000K, 500mA)
DELIVERED LUMEN OUTPUT	88 lm (3000K, 500mA, 20°)
NO. AND TYPE OF LED	1 power LED 1/4 ANSI BIN (white LED color) 50000h L90 B10 (Ta 25°C)
MATERIAL	body and trim in AISI 316L stainless steel lens in transparent, tempered glass
POWER SUPPLY UNIT	Remote power supply required, not included
WIRING	series
MOUNTING	surface mounted (ceiling, wall, ground, spike, strap)
ACCESSORIES	see accessories page
NOTES	not suitable for use in swimming pools or fountains version with elliptical optics and version certified ETL available on request underwater version: Spot 1.0 316L

LUMEN OUTPUT AT SOURCE	145 lm (3000K)
DELIVERED LUMEN OUTPUT	88 lm (3000K, 20°)
NO. AND TYPE OF LED	1 power LED 1/4 ANSI BIN (white LED colour) 50000h L90 B10 (Ta 25°C)
MATERIAL	body and trim in AISI 316L stainless steel lens in transparent, tempered glass
POWER SUPPLY UNIT	Remote power supply required, not included
WIRING	parallel
MOUNTING	surface mounted (ceiling, wall, ground, spike, strap)
ACCESSORIES	see accessories page
NOTES	not suitable for use in swimming pools or fountains version with elliptical optics and version certified ETL available on request underwater version: Spot 1.6 316L,

< SPOT 1.6
2700K, 2W, 40°

Light planning by / MI10studio
Photo by / Germano Borrelli
Il Vittoriale degli Italiani, Gardone Riviera, Brescia, Italy

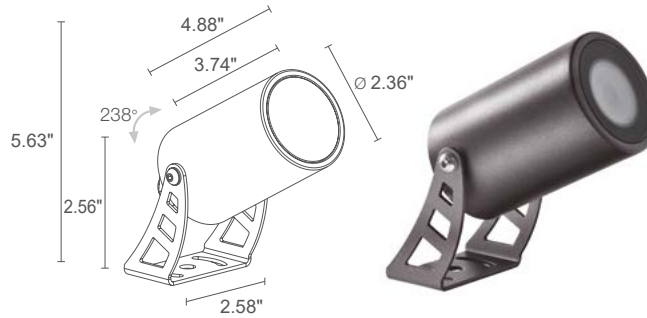
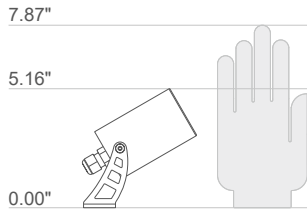

SPOT 2.4



POWER / MODEL CODE	8W 120VAC CF24100000 O E White CF24100000 O H Anthracite
LED COLOR	F - 2700K 5 - 3000K 9 - 4000K
OPTICS	S - 21° M - 29° L - 58°

LUMEN OUTPUT AT SOURCE	586 lm (3000K)
DELIVERED LUMEN OUTPUT	515 lm (3000K, 29°)
NO. AND TYPE OF LED	1 high-intensity power LED 3-step MacAdam 50000h L85 B10 (T _a 25°C)
MATERIAL	body in anticorodal aluminum bracket in aluminum lens in serigraphed and transparent, tempered extra-clear glass
POWER SUPPLY UNIT	built in
POWER CABLE	includes 4.92 ft neoprene cable H05RN-F 3x1.00 Ø 0.28"
MOUNTING	surface mounted (ceiling, wall, ground, spike, strap)
ACCESSORIES	see accessories page
NOTES	Casambi-compatible version, controllable with the Casambi app, available on request



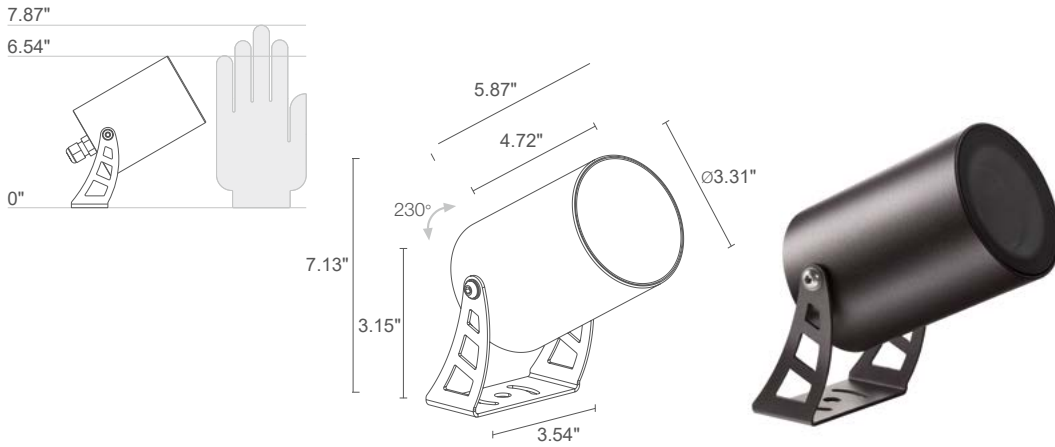

SPOT 3.4

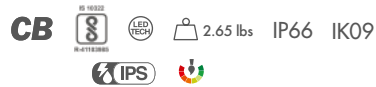

POWER / MODEL CODE	15W 120VAC CF34100000 ■ ■ ■ ■ O ■ ■ ■ E White CF34100000 ■ ■ ■ ■ O ■ ■ ■ H Anthracite
LED COLOR	F - 2700K 5 - 3000K 9 - 4000K
OPTICS	S - 15° M - 39° L - 55°

LUMEN OUTPUT AT SOURCE	1476 lm (3000K)
DELIVERED LUMEN OUTPUT	1042 lm (3000K, 39°)
NO. AND TYPE OF LED	1 COB LED 3-step MacAdam 50000h L90 B10 (T _a 25°C)
MATERIAL	body in anticorodal aluminum bracket in aluminum lens in serigraphed and transparent, tempered extra-clear glass
POWER SUPPLY UNIT	built in
POWER CABLE	includes 4.92 ft neoprene cable H05RN-F 3x1.00 Ø 0.28"
MOUNTING	surface mounted (ceiling, wall, ground, spike, strap)
ACCESSORIES	see accessories page
NOTES	Casambi-compatible version, controllable with the Casambi app, available on request





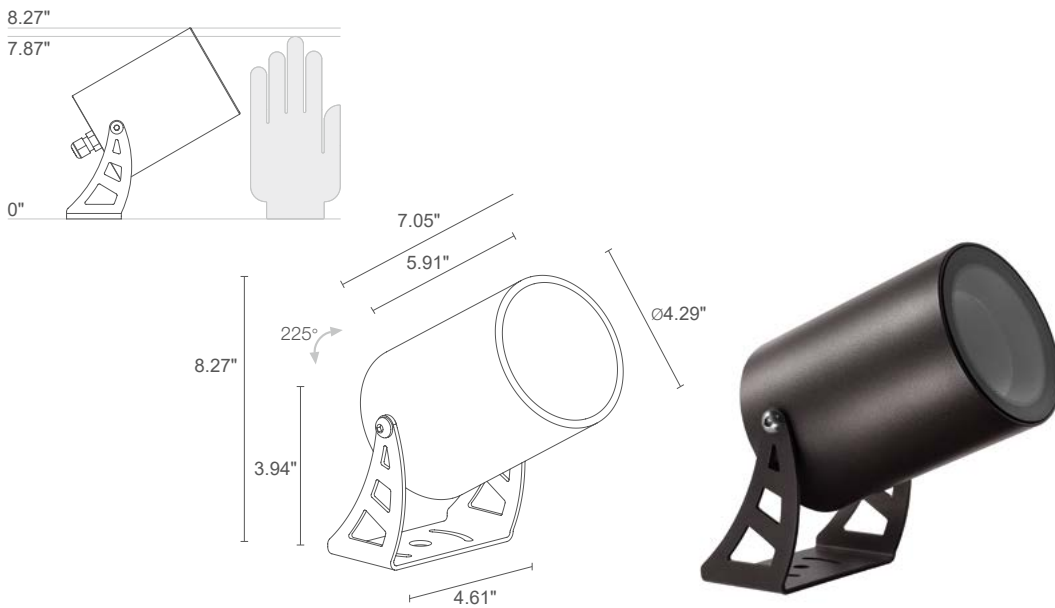

SPOT 4.4

CB IP66 IK08







POWER SUPPLY MODEL CODE	120-277VAC CF441 0000 0 E White CF441 0000 0 H Anthracite
POWER	0 - 22W 1 - 32W
LED COLOR	F - 2700K 5 - 3000K 9 - 4000K
OPTICS	S - 15° M - 24° L - 32° J - 54°

LUMEN OUTPUT AT SOURCE	2365 lm (3000K, 22W) 3010 lm (3000K, 32W)
DELIVERED LUMEN OUTPUT	1923 lm (3000K, 15°, 22W) 2450 lm (3000K, 15°, 32W)
NO. AND TYPE OF LED	1 COB LED, 2-step MacAdam 50000h L90 B10 (Ta 25°C)
MATERIAL	body in anticorodal aluminum bracket in aluminum lens in grey-serigraphed and transparent, tempered extra-clear glass
POWER SUPPLY UNIT	built in
POWER CABLE	includes 4.92 ft neoprene cable H05RN-F 3x1.00 Ø 0.28"
MOUNTING	surface mounted (ceiling, wall, ground, spike)
ACCESSORIES	see accessories page
NOTES	version with honeycomb louvre available on request Casambi-compatible version, controllable with the Casambi app, available on request

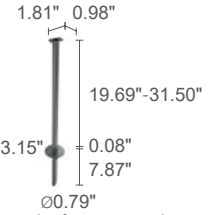

< **SPOT 1.6**
3000K, 2W, 40°

Project by / arch. **Ciro Alfredo Matarante**
 Photo by / **Alessio Tamborini**
 Private residence, Foggia, Italy

	SPOT 1.0	SPOT 1.6	SPOT 2.4	SPOT 3.4	SPOT 4.4
<p>ANTI-GLARE ACCESSORIES</p>  <p>Honeycomb louvre built into the lighting fixture order together with the lighting fixture the honeycomb louvre can be fitted on all optics except for 19° sharp and 54° sharp optics</p>  <p>Standard snoot</p>  <p>Asymmetrical snoot</p>	<p>WHO101</p> <p>WB0320I Stainless steel Ø1.3x0.98"</p> <p>WB0321I Stainless steel Ø1.3x1.24"</p>	<p>WH0101</p> <p>WB0320I Stainless steel Ø1.3x0.98"</p> <p>WB0321I Stainless steel Ø1.3x1.24"</p>	<p>WB1001E White WB1001H Anthracite Ø2.54x2.76"</p> <p>WB1002E White WB1002H Anthracite Ø2.54x3.54"</p>	<p>WB8010E White WB8010H Anthracite Ø3.54x3.35"</p> <p>WB8020E White WB8020H Anthracite Ø3.35x3.62"</p>	<p>WB1101E White WB1101H Anthracite Ø4.53x3.35"</p> <p>WB1102E White WB1102H Anthracite Ø4.33x4.72"</p>
<p>ACCESSORIES FOR INSTALLATION</p>  <p>Spike for in-ground installation</p>  <p>Spike for in-ground installation</p>  <p>Spike for in-ground installation</p>  <p>Fastener strap – 16.40 ft</p>	<p>WP0100</p> <p>WP1004</p>	<p>WP0100</p> <p>WP1004</p>	<p>WP0100</p> <p>h 19.69" WP1006E White WP1006H Anthracite</p> <p>h 31.50" WP1007E White WP1007H Anthracite</p> <p>WP1004</p>	<p>WP0100</p> <p>h 19.69" WP1006E White WP1006H Anthracite</p> <p>h 31.50" WP1007E White WP1007H Anthracite</p> <p>WP1004</p>	<p>WP0300</p>



ACCESSORIES

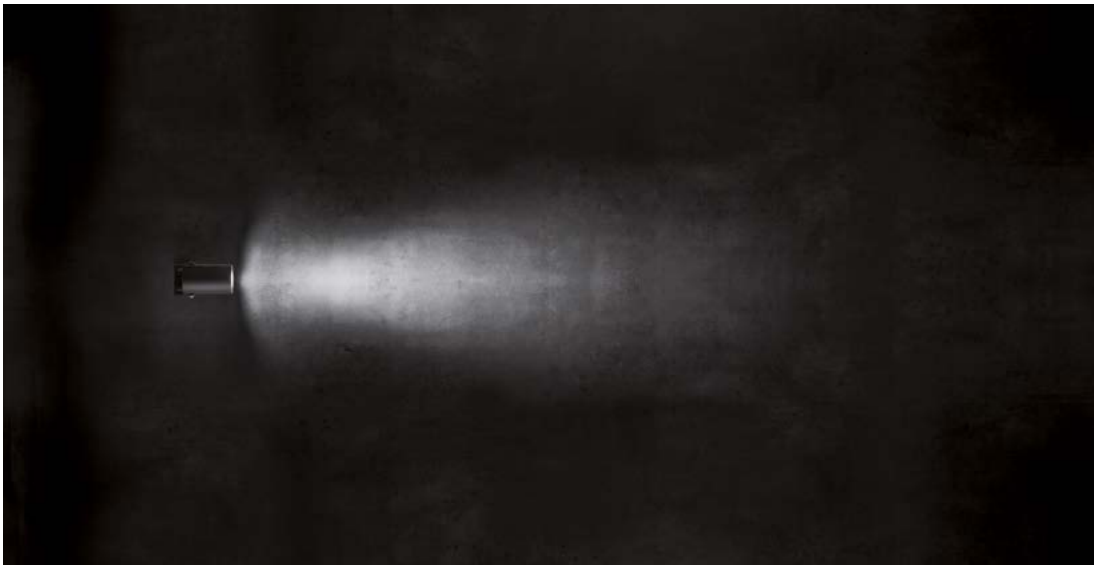

< SPOT 2.4
21°



< SPOT 2.4
29°



< SPOT 2.4
58°



OUTDOOR PROJECTORS

SPOT 1.0 1.6

S - 10°

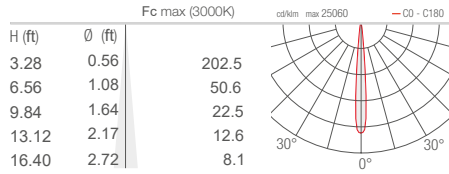

V - 19° sharp

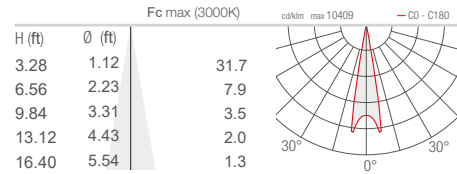

M - 20°

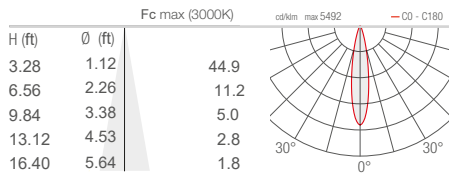

2000

L - 40°

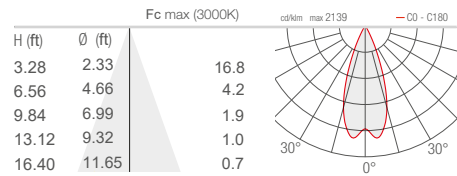

T - 54° sharp

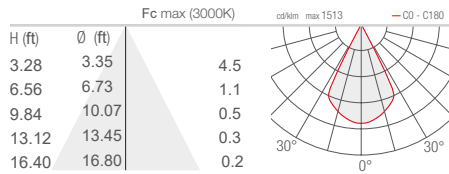

SPOT 2.4

S - 21°

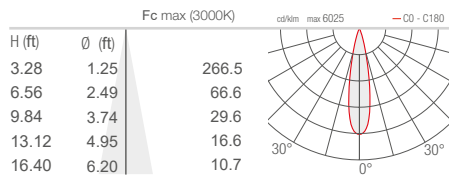

M - 29°

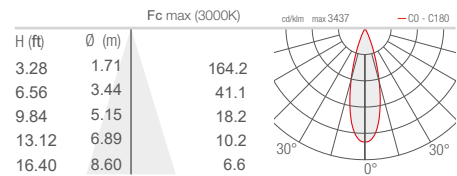

L - 58°

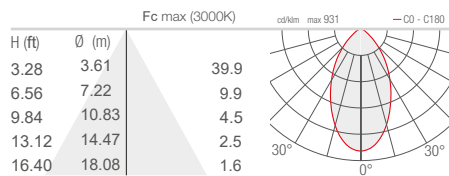

SPOT 3.4

S - 15°

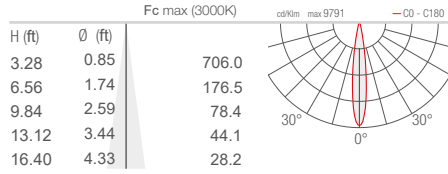

M - 39°

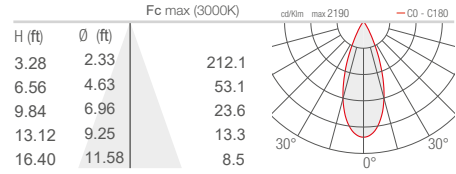

L - 55°

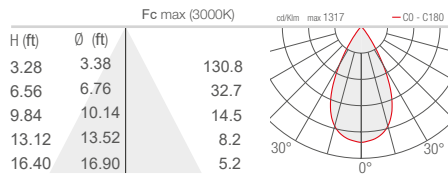

SPOT 4.4

S - 15°

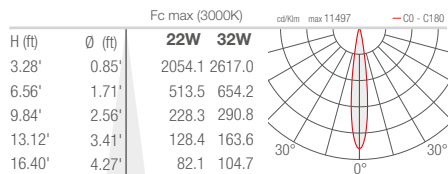

M - 24°

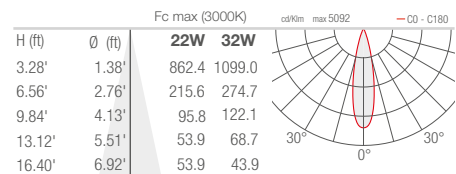

L - 32°

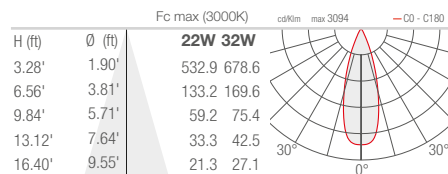

J - 54°

