

STEP OUTSIDE 2.6

The Step Outside 2 Series are discreet semi-recessed LED wall-mounted step lights ideal for illuminating pathways and stairs. Available in 2 styles (square and round) and 3 standard finishes.



TECHNICAL DATA

Wattage / Input	2W (24VDC)
Power Supply	Remote, not included. See page 2.
Construction	Body: Aluminum Lens: Transparent Extra Clear Glass Cable Length: 4.92' standard
CCT	2700K, 3000K, 4000K, 5000K, Blue
CRI	>80
Delivered Lumens	35 lm (3000K, 500mA)
Efficacy	17.5 lm/W
Optics	Diffuse
Finishes	White, Black, Cor-ten, Custom RAL (see below)
Cut-Out Dimensions	Ø1.18"
Fixture Dimensions	1.5" l x 0.71" w x 1.5" h
Fixture Weight	0.40 lbs
LED Source	1 Power LED
Lumen Maintenance	L90, B10 >50,000hrs (Ta 25°C)
Color Consistency	1/4 ANSI BIN
Operating Temp.	-4°F to +113°F
IP Rating	IP54
Impact Rating	IK03
JA8	Exempt

Wall Cut-Out: Ø1.18"
Fixture Dimensions
1.5" l x 0.71" w x 1.5" h

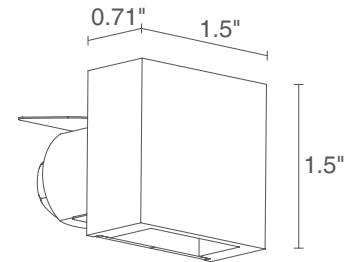

ORDERING INFORMATION

Example: SP26009DN or SP26009DN-2. Accessories / Power Supplies ordered separately.

SP2600		D		
Model No.	CCT	Optics	Finish	Cable Length
SP2600	F - 2700K 5 - 3000K 9 - 4000K 0 - 5000K 1 - Blue	D - Diffuse	E - White N - Black T - Cor-ten C - Custom RAL (consult factory for "C")	4.92' standard 1 - 16.40' 2 - 32.81' 3 - 49.21' 4 - 65.62'

Job Name/Date:

Fixture Type Designation:

SUGGESTED POWER SUPPLIES

24VDC

Part Number	Description	Input/Output	# of Fixtures
PPLT00275	Non-Dim	120-277VAC to 24VDC, 12W, Class 2, IP66	1-4
PPLT00632	0-10V Dimming (Dim to Off)	120-277VAC to 24VDC, 12W, Class 2	1-4
PPLT00056	Non-Dim	120-277VAC to 24VDC, 26W, Class 2, IP66	1-10
PPLT00586	Non-Dim	120-277VAC to 24VDC, 40W, Class 2	1-16
PPLT00709	ELV/TRIAC & 0-10V Dimming to 5% and OFF	120-277VAC to 24VDC, 96W, Class 2, DAMP	1-38
PPLT00543	0-10V Dimming to 15% (-40°C / -40°F cold weather start)	120-277VAC to 24VDC, 100W, Class 2	5-40

Suggested Lutron Compatible

Part Number	Option	Lutron SKU	Dim Range	Description	Input/Output	# of Fixtures
PPLT00273	L3DAE / L3DA3W	L3DA	100%-1%	Hi-Lume™ 1% EcoSystem™ or 1% 3-Wire LED Driver	120-277VAC to 24VDC, 40W, Class 2	1-16
PPLT00530	L3D0	L3D0	100%-0.1%	Hi-Lume™ Premier 0.1% or Ecosystem 3-Wire LED Driver	120-277VAC to 24VDC, 96W, Class 2	1-38

For other power supply options consult factory.

ACCESSORIES

Installation

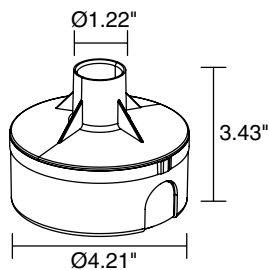

WC0202
Outer Casing

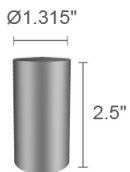

PPMP02674
Core Drilled
Application Sleeve

Job Name/Date:

Fixture Type Designation:

STEP OUTSIDE 2.6

PHOTOMETRIC DATA

Note all Photometry is 3000K

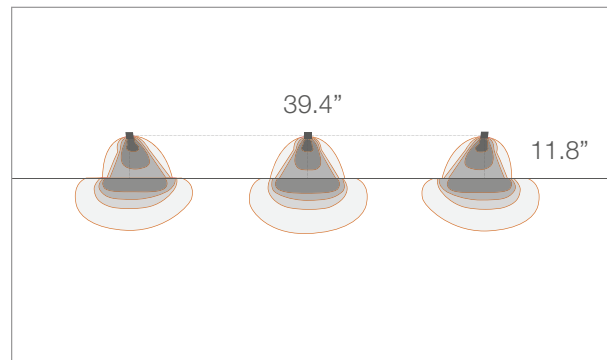
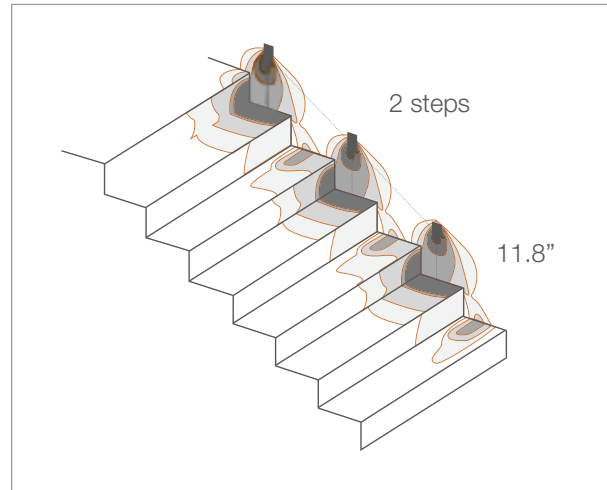
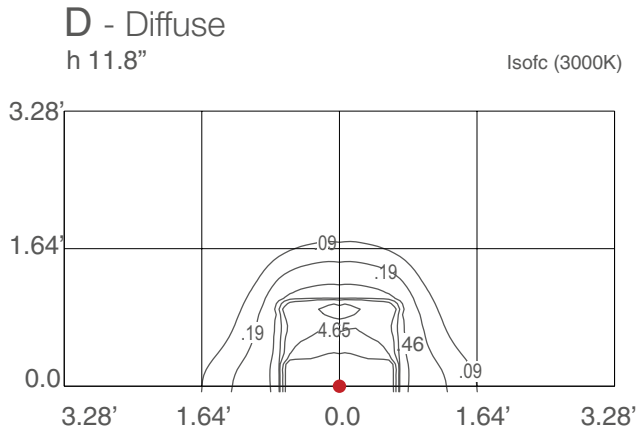

Job Name/Date:

Fixture Type Designation: