

STEP OUTSIDE 6.3

The Step Outside 5 & 6 series are recessed LED wall-mounted spotlights, ideal for pathway and stair lighting. Available in 5 different styles (round and square) and 4 standard finishes.



TECHNICAL DATA

Wattage / Input	2W (500mA)
Power Supply	Remote, not included. See page 2.
Construction	Body: Aluminum Trim: Stainless Steel Lens: Transparent Plexiglass Cable Length: 4.92' standard
CCT	2700K, 3000K, 4000K, 5000K, Blue
CRI	>80
Delivered Lumens	25 lm (3000K, 500mA)
Efficacy	12.5 lm/W
Optics	Asymmetric
Finishes	White, Black, Cor-ten, Satin, Custom RAL (see below)
Cut-Out Dimensions	Ø1.77"
Fixture Dimensions	2.05" l x 2.17" w x 2.17" h
Fixture Weight	0.53 lbs
LED Source	1 Power LED
Lumen Maintenance	L90,B10 >50,000hrs (Ta 25°C)
Color Consistency	1/4 ANSI BIN
Operating Temp.	-4°F to +113°F
IP Rating	IP65
Impact Rating	—
JA8	Exempt

Wall Cut-Out: Ø1.77"
Fixture Dimensions
2.05" l x 2.17" w x 2.17" h

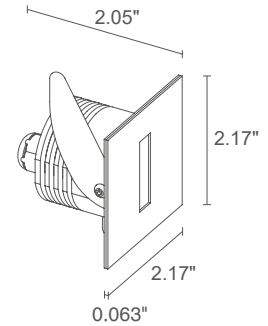

ORDERING INFORMATION

Example: SP63129AAE or SP63129AAE-2. Accessories / Power Supplies ordered separately.

SP6312		A		
Model No.	CCT	Optics	Finish	Cable Length
SP6312	F - 2700K 5 - 3000K 9 - 4000K 0 - 5000K 1 - Blue	A - Asymmetric	AE - White AN - Black AT - Cor-ten AS - Satin C - Custom RAL Number Only (consult factory for "C")	4.92' standard 1 - 16.40' 2 - 32.81' 3 - 49.21' 4 - 65.62'

Job Name/Date:

Fixture Type Designation:

SUGGESTED POWER SUPPLIES

500mA

Part Number	Description	Input/Output	# of Fixtures
PPLT00497	Phase Dim (120V only)	120VAC to 500mA, 12W, Class 2	2-6
PPLT00465-P	0-10V Dimming to 1.0%	120-277VAC to 500mA, 20W, Class 2	1-10
PPLT00309-P	0-10V Dimming to 0.1%	120-277VAC to 500mA, 50W, Class 2	1-16
PPLT00467-P	0-10V Dimming to 1.0%	120-277VAC to 500mA, 50W, Class 2	1-16

For other power supply options consult factory.

ACCESSORIES

Installation



WC1501
Outer Casing

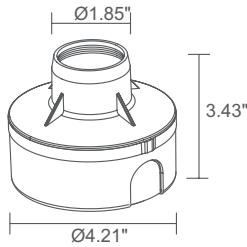

PMP03113
Core Drilled
Application Sleeve

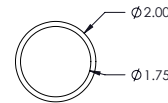
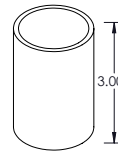

Job Name/Date:

Fixture Type Designation:

STEP OUTSIDE 6.3

PHOTOMETRIC DATA

Note all Photometry is 3000K

A - Asymmetrical

h 11.81"

Isofc (3000K)

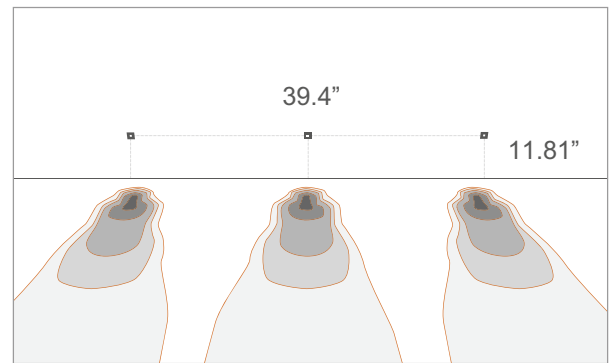
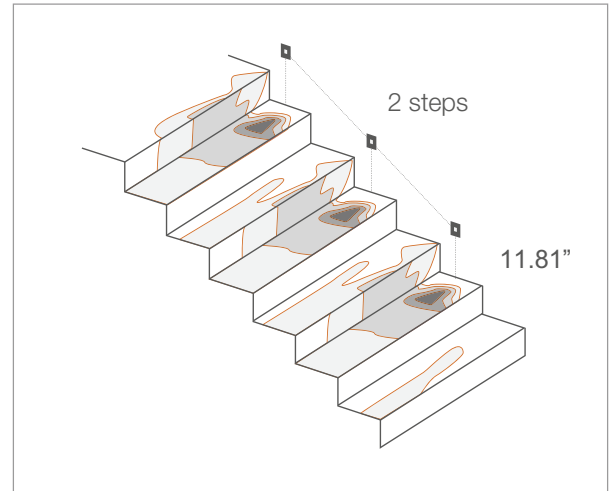
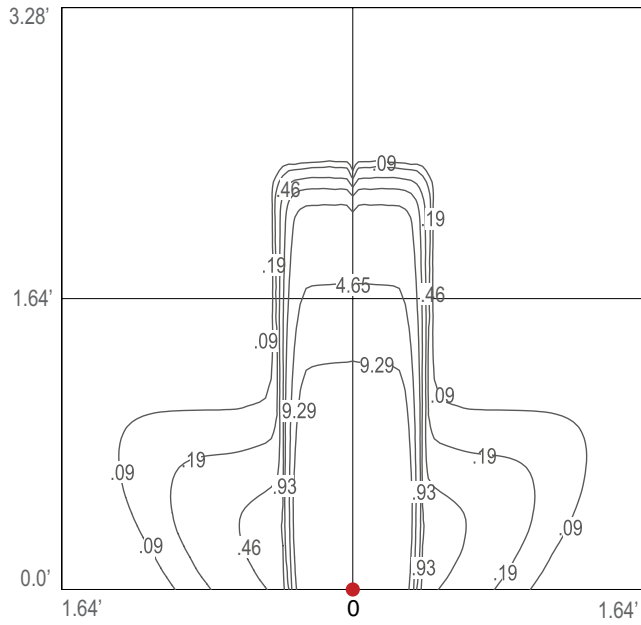

Job Name/Date:

Fixture Type Designation: